

# Vertical loading and atmospheric parameters

T. A. Herring      M. A. Floyd  
*Massachusetts Institute of Technology*

GAMIT/GLOBK/TRACK Short Course for GPS Data Analysis  
Korea Institute of Geoscience and Mineral Resources (KIGAM)  
Daejeon, Republic of Korea  
23–27 May 2016

Material from T. A. Herring, R. W. King, M. A. Floyd (MIT) and S. C. McClusky (now ANU)

# OVERVIEW

- Atmospheric delay treatment and issues
  - GAMIT setup for different approaches
  - Impacts of atmospheric modeling
- Loading
  - GAMIT setup and some results
- Estimating and extracting atmospheric parameters
- Impact of other models on vertical
  - Antenna calibrations
  - Elevation angle
  - Antenna height in multipath environment

# Challenges and Opportunities in GPS Vertical Measurements

- “One-sided” geometry increases vertical uncertainties relative to horizontal and makes the vertical more sensitive to session length
- For geophysical measurements the atmospheric delay and signal scattering are unwanted sources of noise
- For meteorological applications, the atmospheric delay due to water vapor is an important signal; the hydrostatic delay and signal scattering are sources of noise
- Loading of the crust by the oceans, atmosphere, and water can be either signal or noise
- Local hydrological uplift or subsidence can be either signal or noise
- Changes in instrumentation are to be avoided

# Atmospheric model

- The apriori models used in GAMIT for the atmospheric delays are controlled by the sestbl. entries:

```
Met obs source = UFL GPT 50 ; hierarchical list
                  with humidity value at the end; e.g.
                  RNX UFL GPT 50 ; default GPT 50
```

```
DMap = VMF1 ; GMF(default)/VMF1/NMFH;
            GMF now invokes GPT2 if gpt.grid is
            available (default)
```

```
WMap = VMF1 ; GMF(default)/VMF1/NMFW
```

```
Use map.list = N ; VMF1 list file with
                  mapping functions, ZHD, ZWD, P, Pw,
                  T, Ht
```

```
Use map.grid = Y ; VMF1 grid file with
                  mapping functions and ZHD
```

- Above would use Vienna mapping functions and met data (surface pressure) from these files. Recommended but not default because of need for grid files.

# Setup to use VMF1

- To use VMF1: Met and mapping functions
  - you need to download vmf1grd.YYYY from everest.mit.edu
  - Create links in ~/gg/tables between map.grid.YYYY and the vmf1 files (due to size we assume they may stored in some other location)
  - sh\_gamit will automatically link day directory files to your gg/tables files.
- The met source is hierarchical but the mapping functions must specified.

# Impact of met source

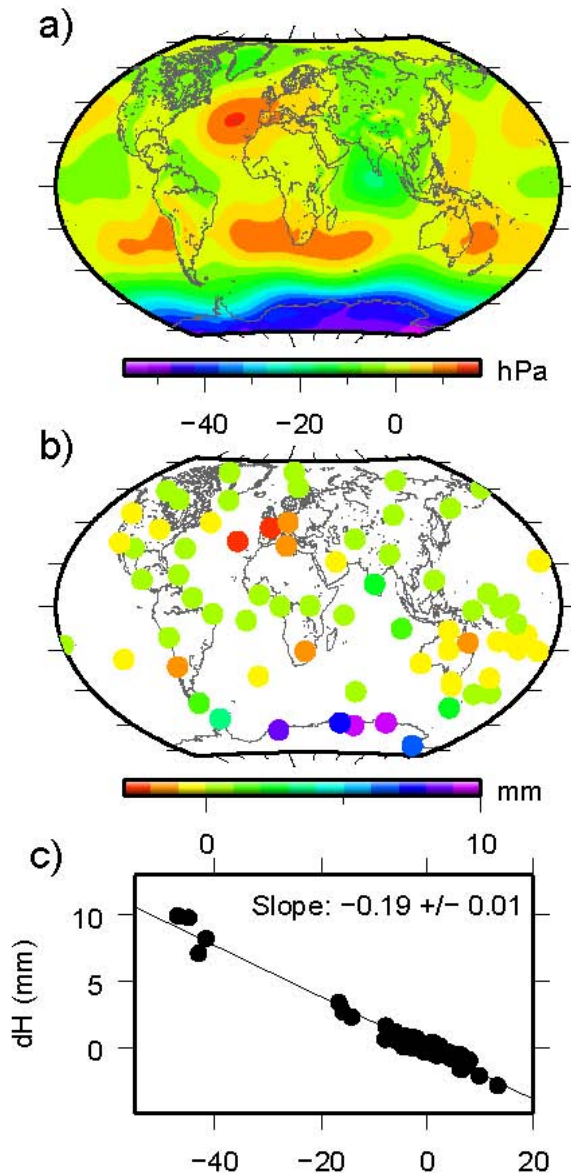

- Difference between a) surface pressure derived from “standard” sea level pressure and the mean surface pressure derived from the GPT model.

b) station heights differences using the two sources of a priori pressure.

c) Relation between a priori pressure differences and height differences. Elevation-dependent weighting was used in the GPS analysis with a minimum elevation angle of 7 deg.

# Short-period Variations in Surface Pressure not Modeled by GPT

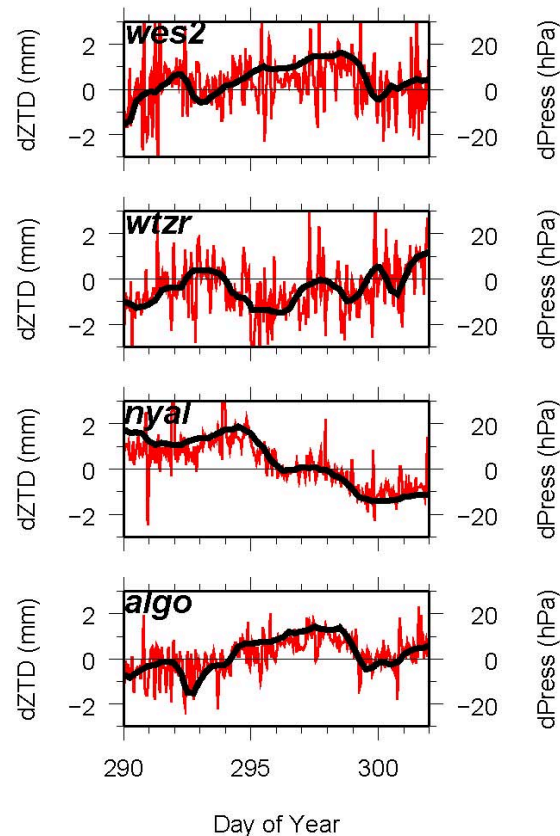

Differences in GPS estimates of ZTD at Algonquin, Ny Alessund, Wettzell and Westford computed using static or observed surface pressure to derive the a priori. Height differences will be about twice as large. (Elevation-dependent weighting used).

# Loading Effects

- Invoking in GAMIT; sestbl. Entries

```
Tides applied = 31 ; Binary coded: 1 earth  2 freq-dep  4 pole  
      8 ocean  16 remove mean for pole tide  
      ; 32 atmosphere ; default = 31
```

```
Use otl.list = N ; Ocean tidal loading list file from OSO
```

```
Use otl.grid = Y ; Ocean tidal loading grid file, GAMIT-  
format converted from OSO
```

```
Apply atm loading = N ; Y/N for atmospheric loading
```

```
Use atml.list = N ; Atmospheric (non-tidal) loading list  
file from LU
```

```
Use atml.grid = N ; Atmospheric (non-tidal) loading grid  
file from LU, converted to GAMIT format
```

```
Use atl.list = N ; Atmospheric tides, list file, not yet  
available
```

```
Use atl.grid = N ; Atmospheric tides, grid file
```

- Default settings. Consistent with IGS ITRF2014 contribution (i.e., no non-tidal loading applied).



# To apply “Tidal” loading

- Ocean tidal loading is needed. Link otl.grid in gg/tables to otl\_FES2004.grid (download from everest.mit.edu; not included in standard tar files due to size). Close to the coast in complicated regions, list values specific to a location might be better. Be careful that nearby sites don't from different sources.
- “Tidal” atmospheric pressure loading atl.grid has diurnal and semidiurnal S1 and S2 load. Nominally removed from 6hr tabular atmospheric loading values before interpolation (usefulness of this model is not clear --- mostly harmless).

# Ocean loading magnitudes

Radial Ocean Loading Effects

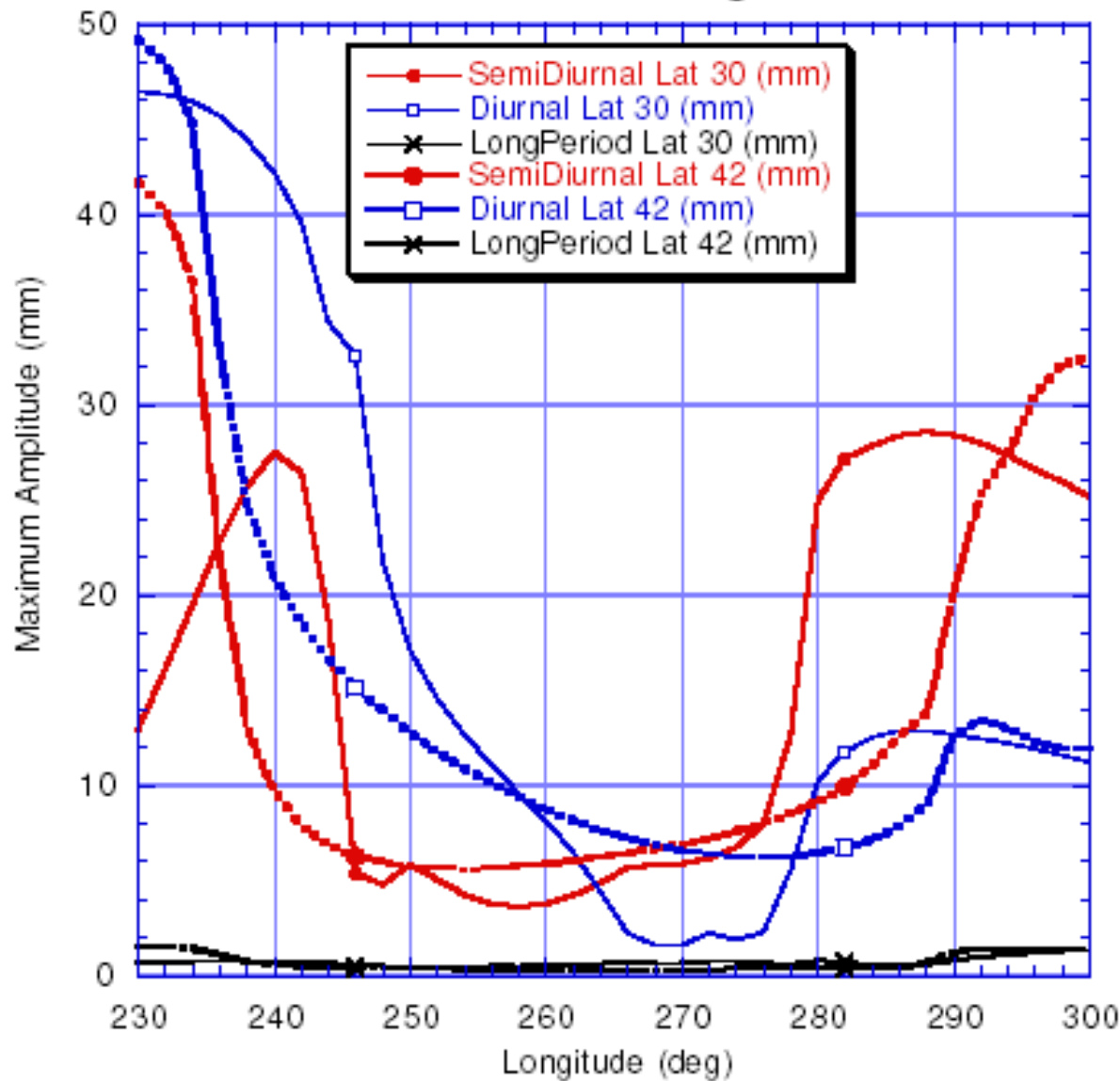

Locations at "corners"

WES2	288.5	42.6
ALBH	236.5	48.4
RICH	279.6	25.6
SIO	242.8	32.8

# To apply non-tidal loading

- Set sestbl. for atml.grid and link atml.grid.YYYY in gg/tables to the appropriate grid files. (atml.list option currently not used).
- When linking atml.grid, there are choices of loading types (files available in GRIDS on everest.mit.edu)
  - atmdisp\_cm.YYYY: Center of mass, 6hr raw data
  - atmfilt\_cm.YYYY: Center of mass, filtered to remove periods less than ~1.2 day. Should be used with S1/S2 atl.grid file.
  - Center of figure (cf) and center of earth (ce) frames are available also (these frames are almost identical).
- When working in current year, near realtime, updated files from everest need to be downloaded regularly.
- Atml Loading applied in GAMIT can be removed in GLOBK with the appl\_mod command.
- Hydrology loading is supported in the file formats but is currently not implemented in GAMIT.

# Annual Component of Vertical Loading

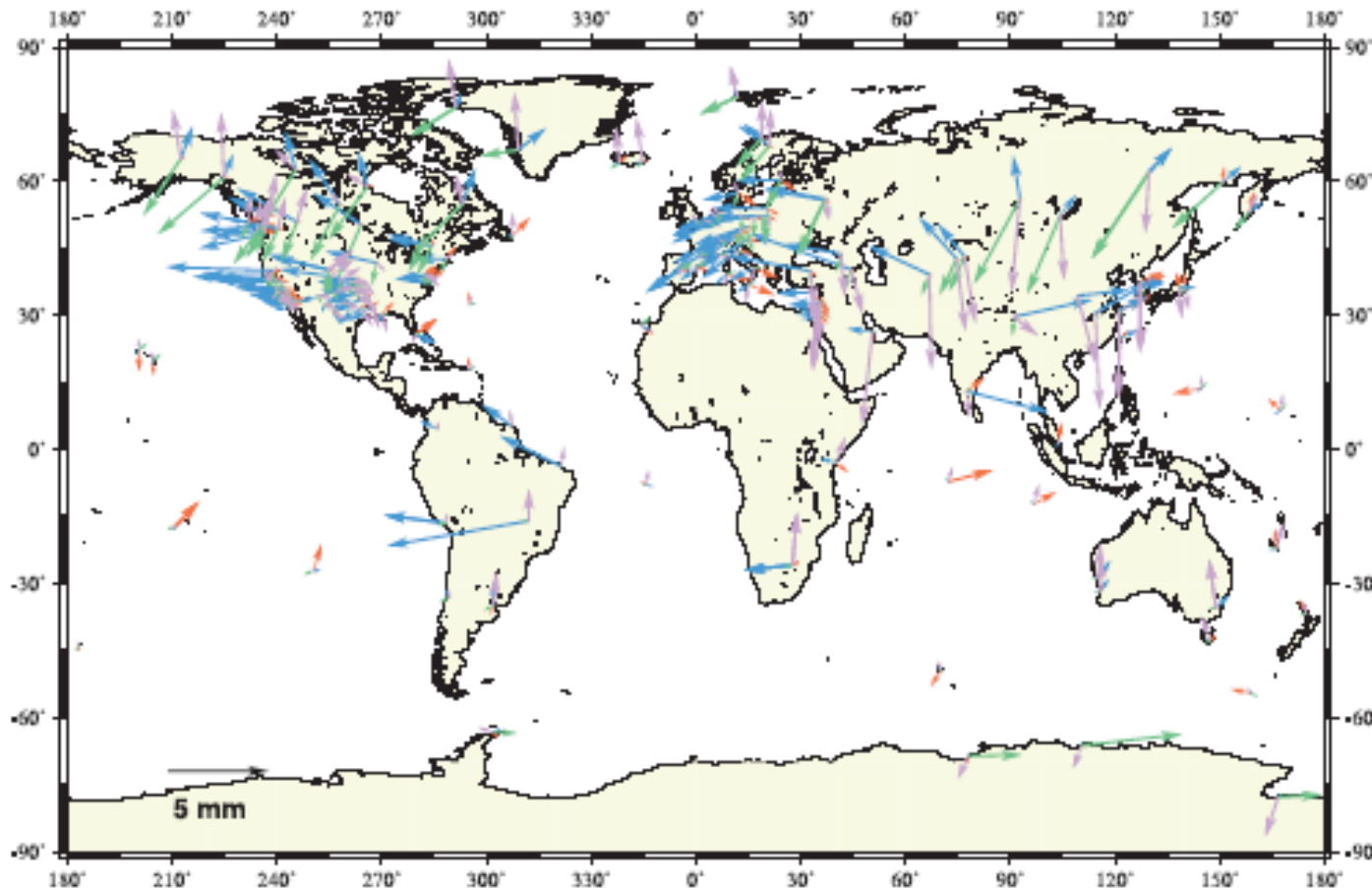

Atmosphere (purple)  
2-5 mm

Snow/water (blue)  
2-10 mm

Nontidal ocean (red)  
2-3 mm

From Dong et al. *J. Geophys. Res.*, 107, 2075, 2002

# Atmospheric pressure loading near equator

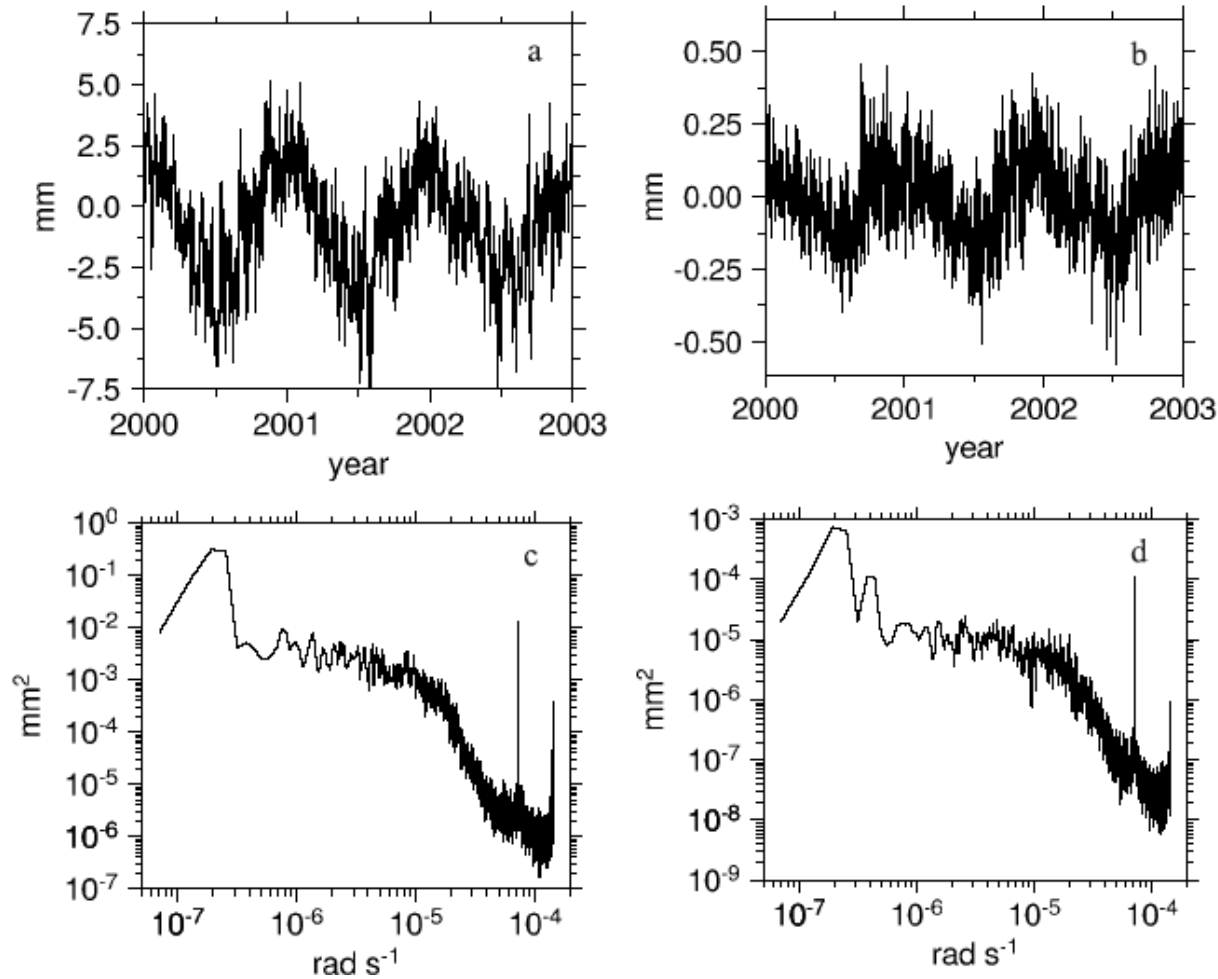

Vertical (a) and north (b) displacements from pressure loading at a site in South Africa. Bottom is power spectrum. Dominant signal is annual. From *Petrov and Boy (2004)*

# Atmospheric pressure loading at mid-latitudes

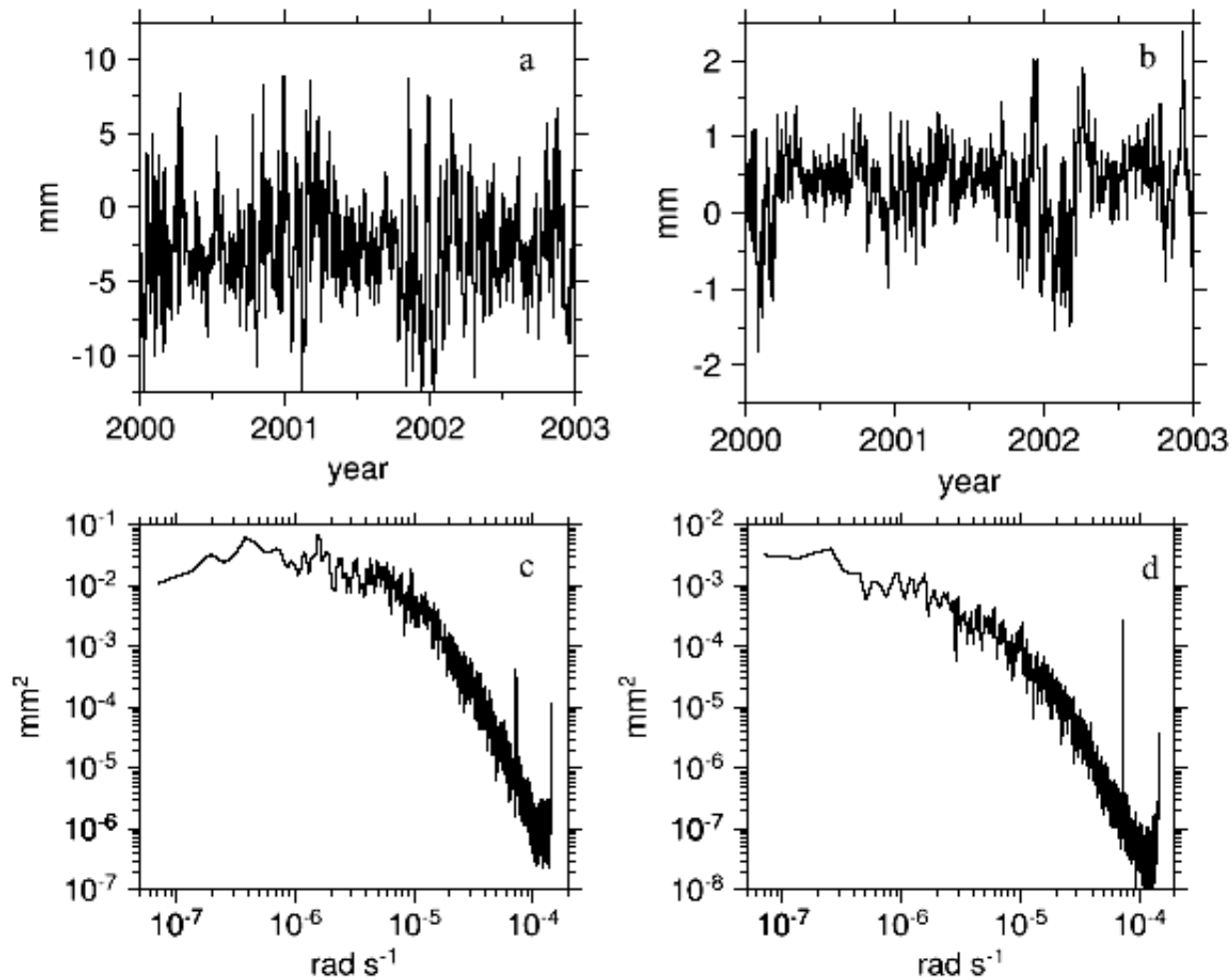

Vertical (a) and north (b) displacements from pressure loading at a site in Germany. Bottom is power spectrum. Dominant signal is short-period.

BURN North Offset 4762193.218 m  
rate(mm/yr)=  $1.39 \pm 0.04$  nrms= 0.69 wrms= 1.5 mm # 1578

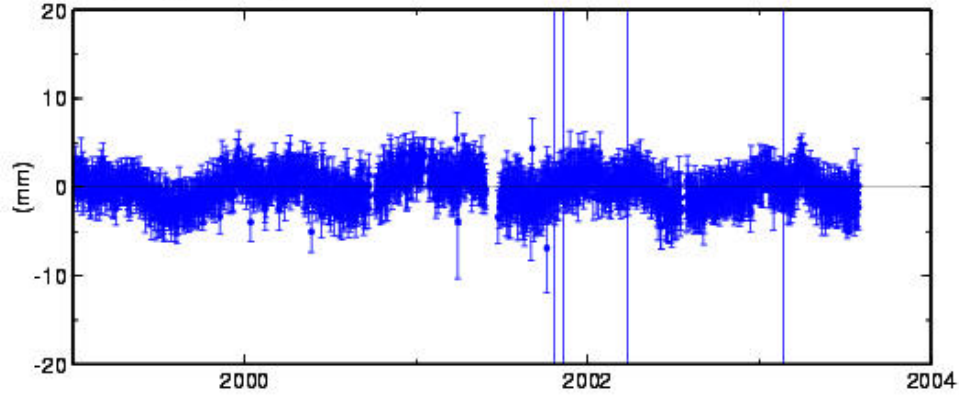

BURN East Offset 19785454.795 m  
rate(mm/yr)=  $-1.43 \pm 0.05$  nrms= 0.86 wrms= 2.1 mm # 1578

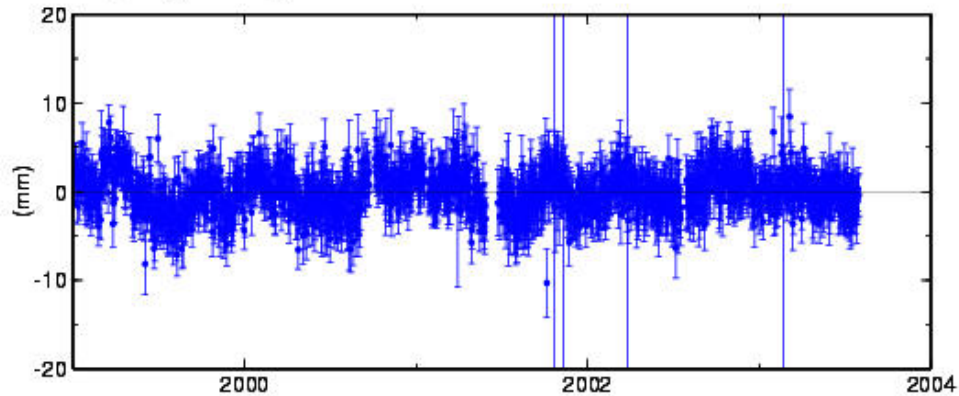

BURN Up Offset 1180.839 m  
rate(mm/yr)=  $-1.62 \pm 0.13$  nrms= 0.79 wrms= 5.5 mm # 1578

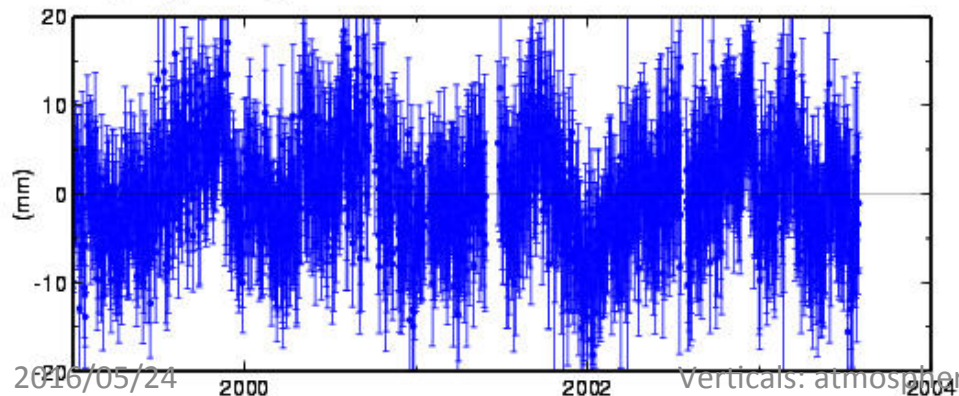

Time series for  
continuous station in  
(dry) eastern Oregon

Vertical wrms 5.5 mm,  
higher than the best  
stations. Systematics  
may be atmospheric or  
hydrological loading,  
Local hydrology, or  
Instrumental effects

# Example: Atmospheric load

- AB27 in central Alaska

Site AB27

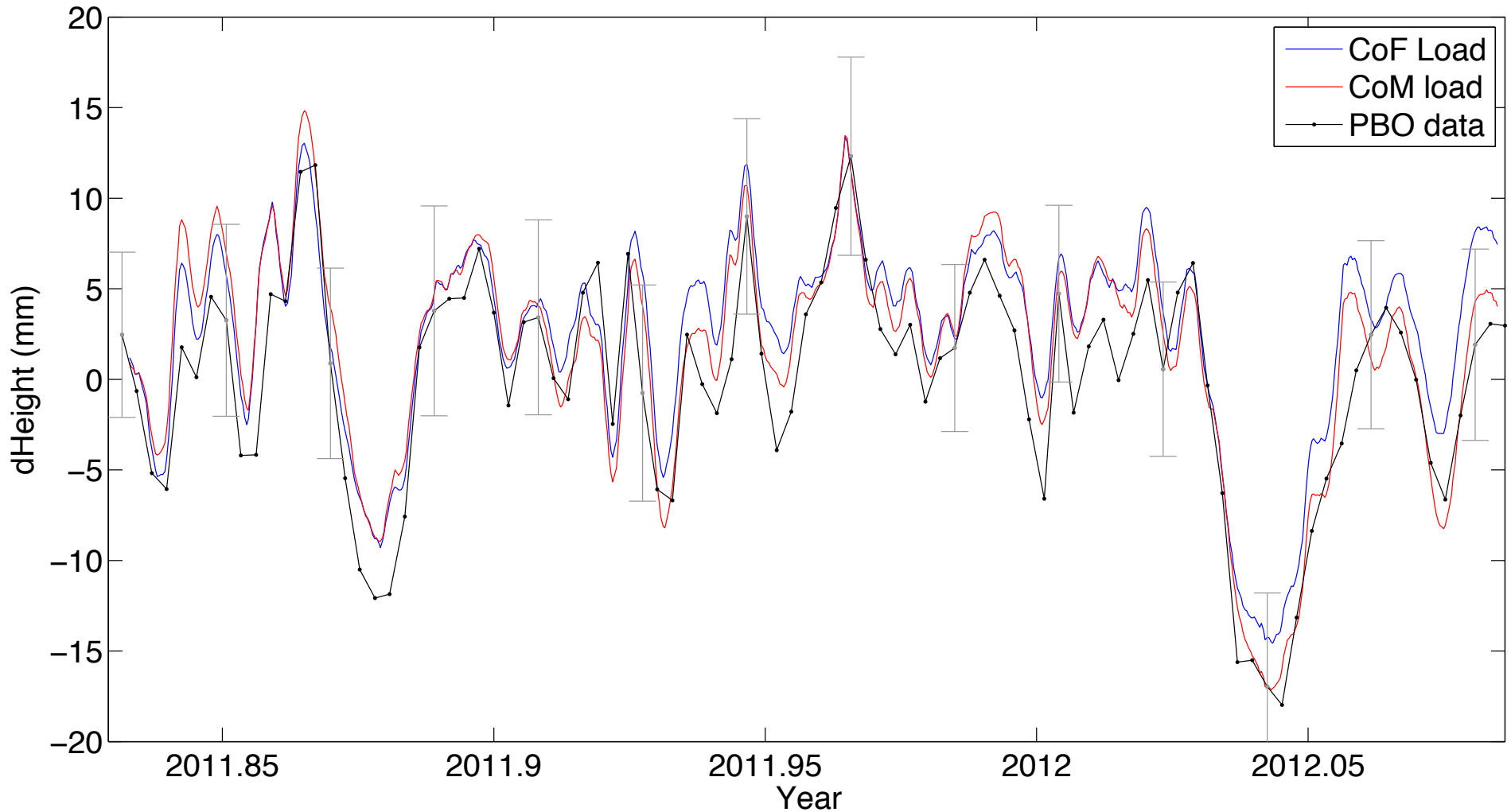



# Example: Atmospheric load

- AC52 in Southern coastal Alaska

Site AC52

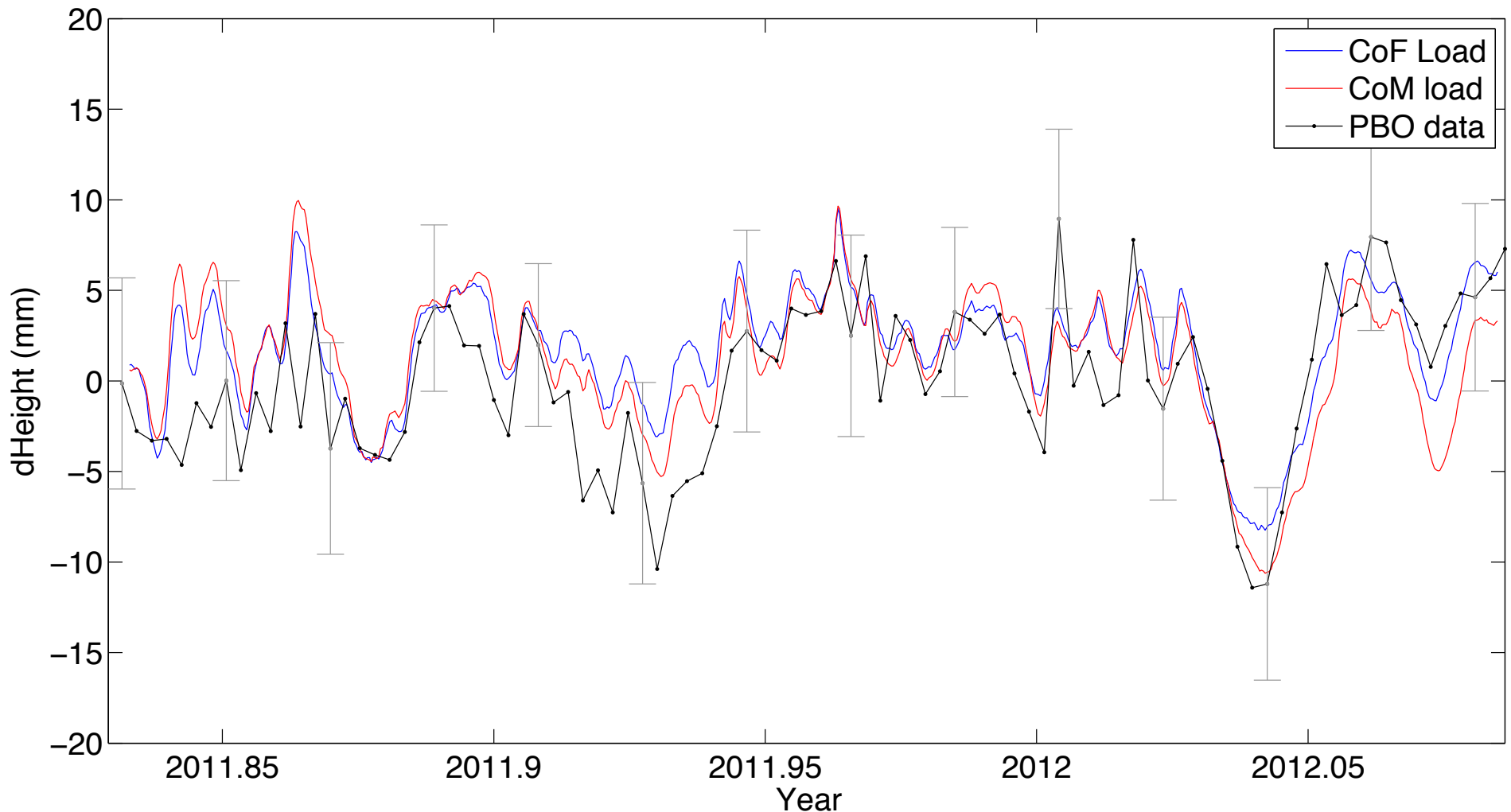

# Example: Atmospheric load

- AC52 in Southern coastal Alaska: North

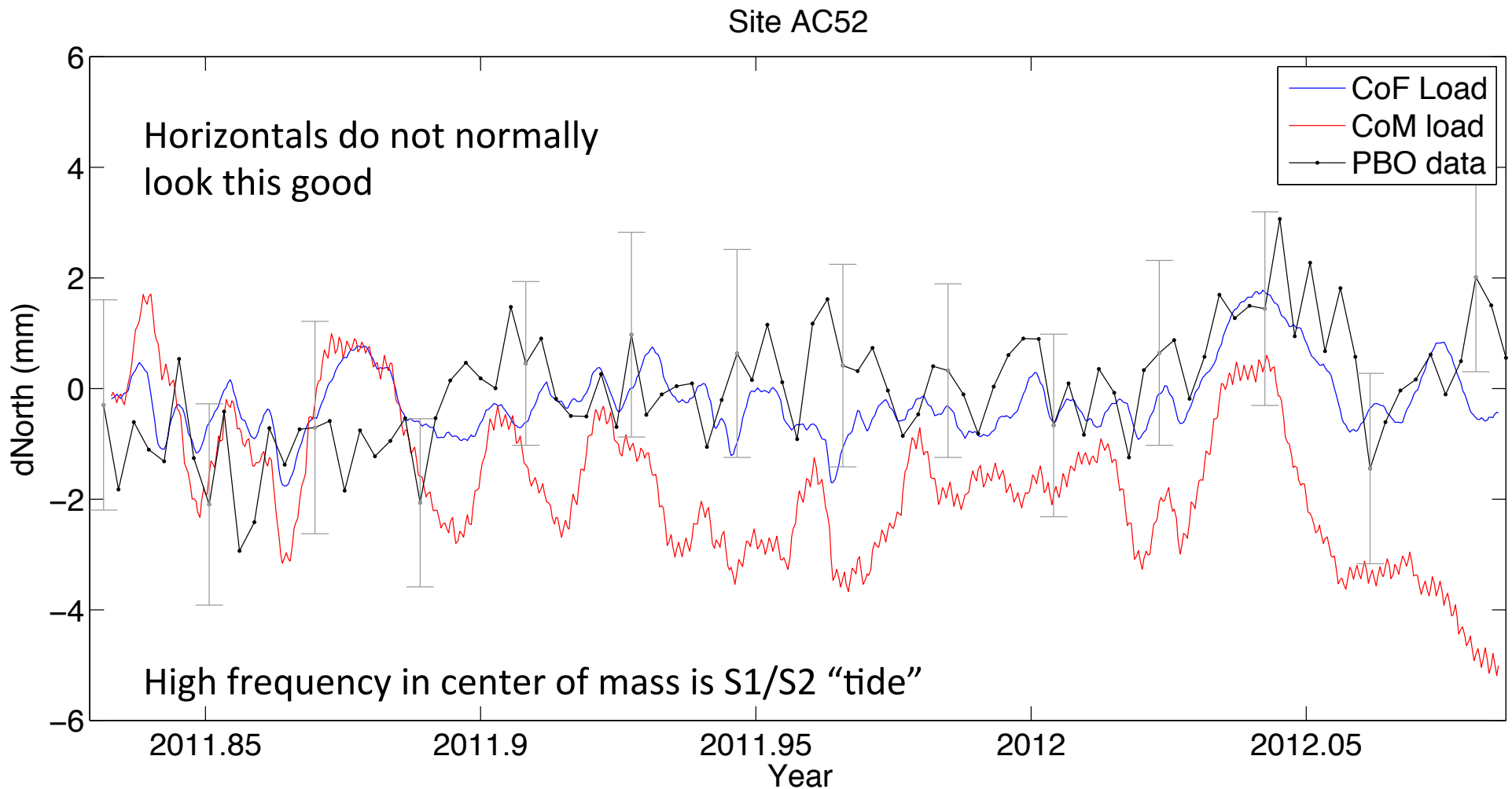

# Severe meteorological conditions

- Other factors to consider:
  - Rapid change in atmospheric pressure affects (dry) hydrostatic delay (mostly function of pressure and temperature)
    - Low pressure reduces ZHD, possibly making site *appear* higher (consider position constraint)
    - BUT, also reduces atmospheric loading, which *physically raises* site position ( $\sim 0.5$  mm/hPa)
    - BUT, additional loading due to raised sea-level (“inverted barometer”) *physically lowers* site position proportionally near coasts
  - Heavy rainfall creates short-term, unmodelled surface loading
  - Storm surge creates short-term, unmodelled ocean loading
    - Additional loading *physically lowers* site position
- How to deconvolve competing physical and apparent effects?

# Effect of the Neutral Atmosphere on GPS Measurements

$$\text{Slant delay} = (\text{Zenith Hydrostatic Delay}) * (\text{“Dry” Mapping Function}) + (\text{Zenith Wet Delay}) * (\text{Wet Mapping Function})$$

- To recover the water vapor (ZWD) for meteorological studies, you must have a very accurate measure of the hydrostatic delay (ZHD) from a barometer at the site.
- For height studies, a less accurate model for the ZHD is acceptable, but still important because the wet and dry mapping functions are different (see next slides)
- The mapping functions used can also be important for low elevation angles
- For both a priori ZHD and mapping functions, you have a choice in GAMIT of using values computed at 6-hr intervals from numerical weather models (VMF1 grids) or an analytical fit to 20-years of VMF1 values, GPT and GMF (defaults)

## Sensing Atmospheric Delay

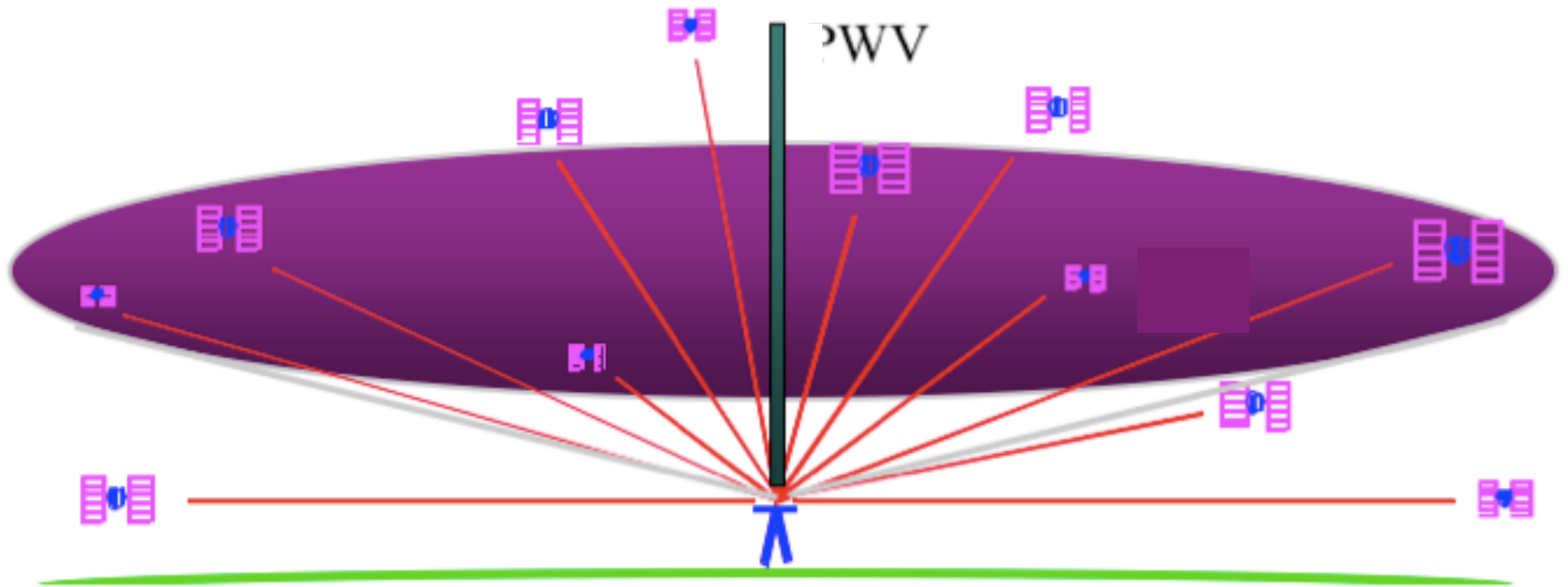

The signal from each GPS satellite is delayed by an amount dependent on the pressure and humidity and its elevation above the horizon. We invert the measurements to estimate the average delay at the zenith (green bar).

( Figure courtesy of COSMIC Program )

# Zenith delay from wet and dry components of the atmosphere

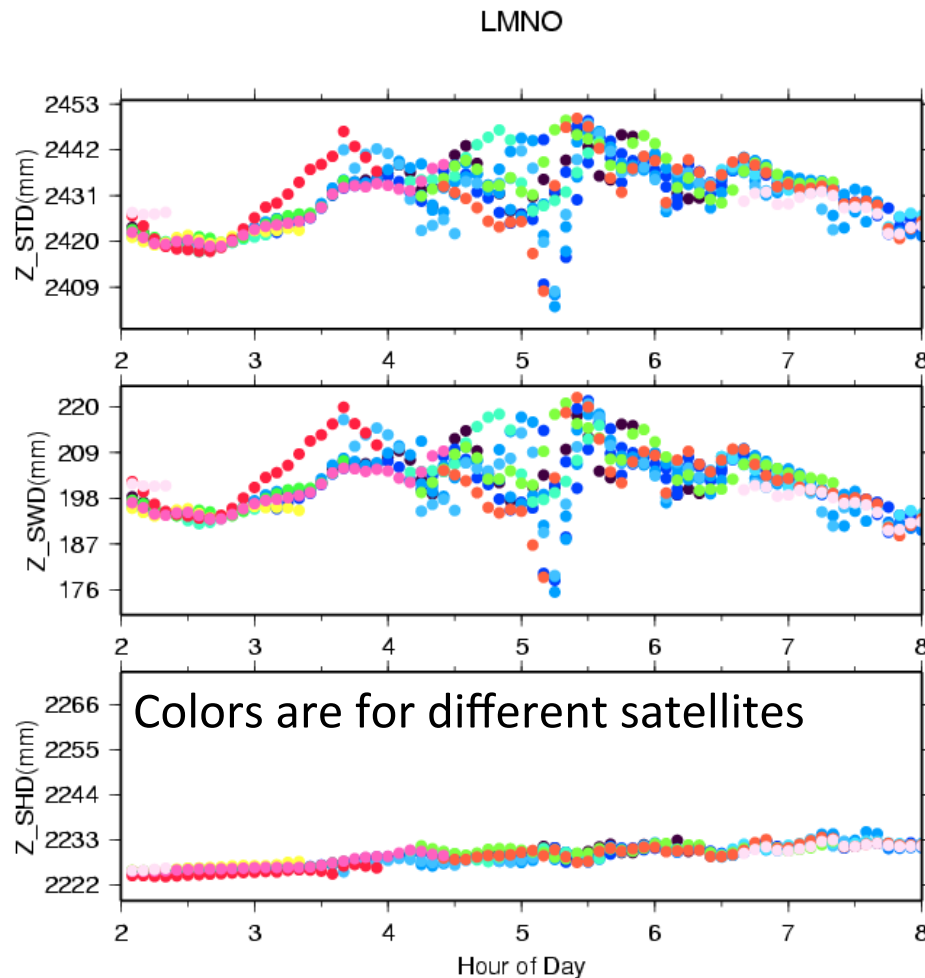

- Total delay is  $\sim 2.5$  m
- Hydrostatic delay is  $\sim 2.2$  m
  - Little variability between satellites or over time
  - Well calibrated by surface pressure
- Variability mostly caused by wet component
- Wet delay is  $\sim 0.2$  meters, obtained by subtracting the hydrostatic (dry) delay.

Courtesy of J. Braun (UCAR)

# Example of GPS water vapor time series

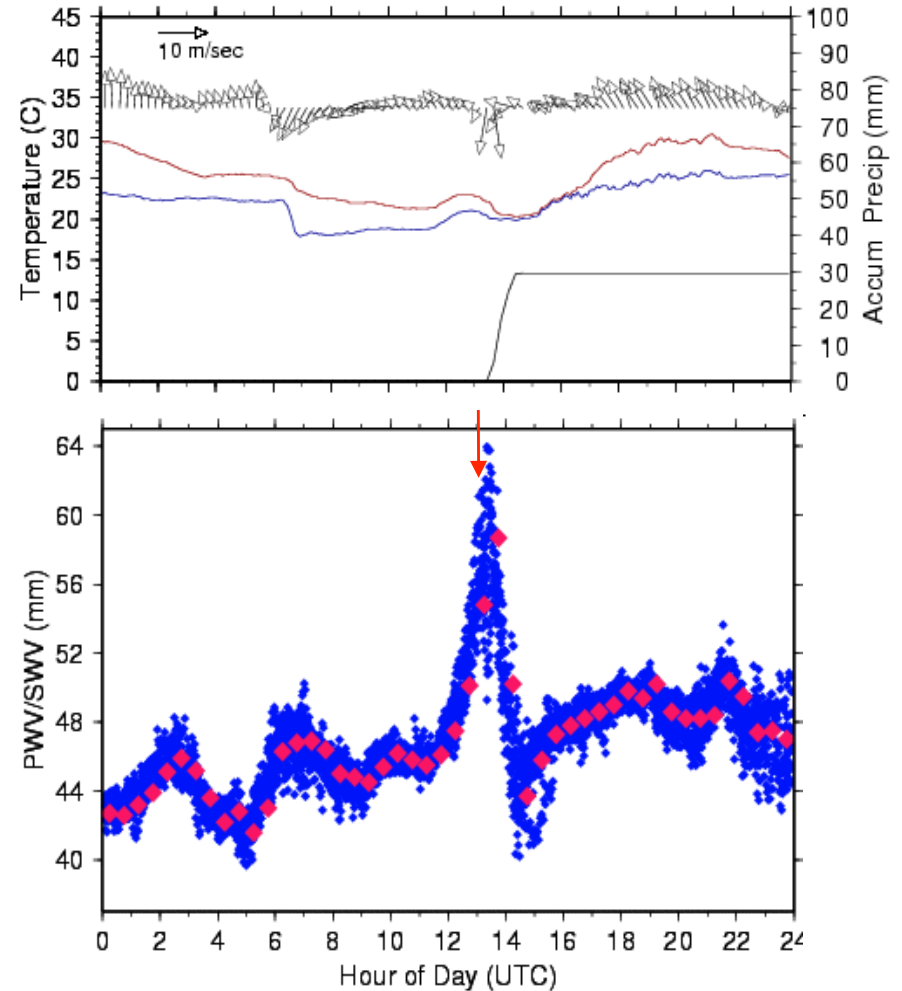
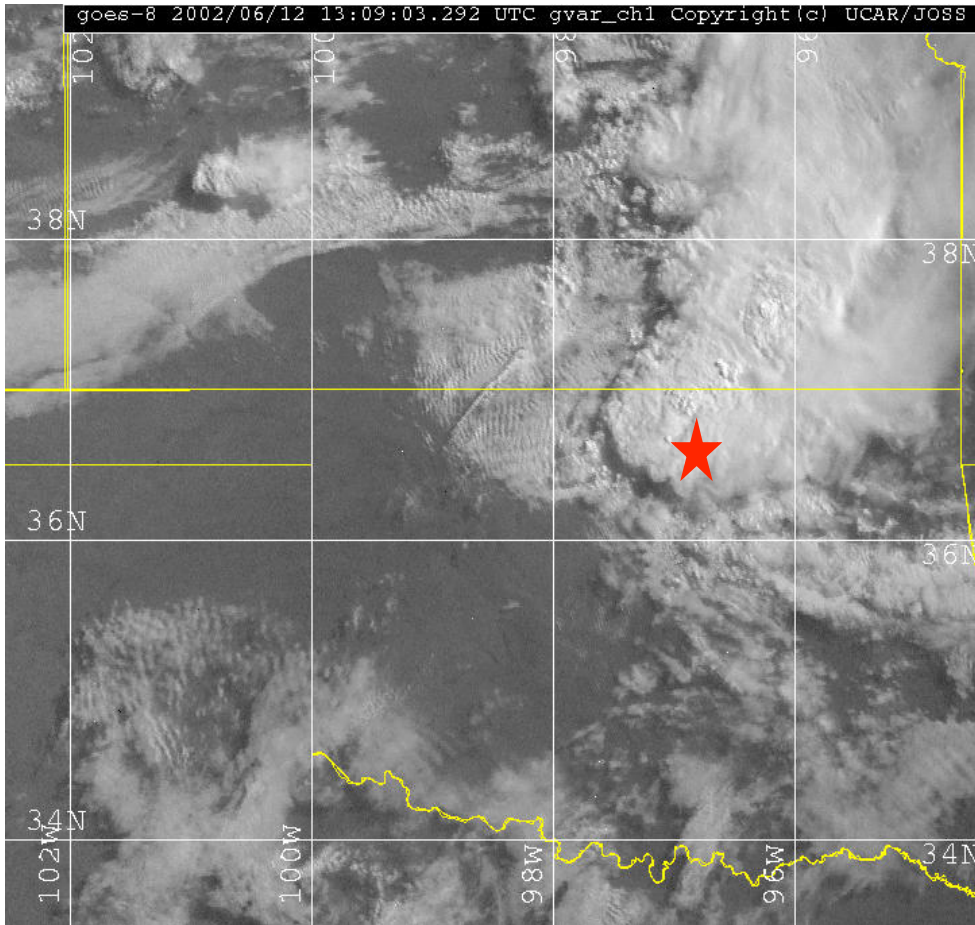

GOES IR satellite image of central US on left with location of GPS station shown as red star. Time series of temperature, dew point, wind speed, and accumulated rain shown in top right. GPS PW is shown in bottom right. Increase in PW of more than 20mm due to convective system shown in satellite image.

# Water vapor as a proxy for pressure in storm prediction

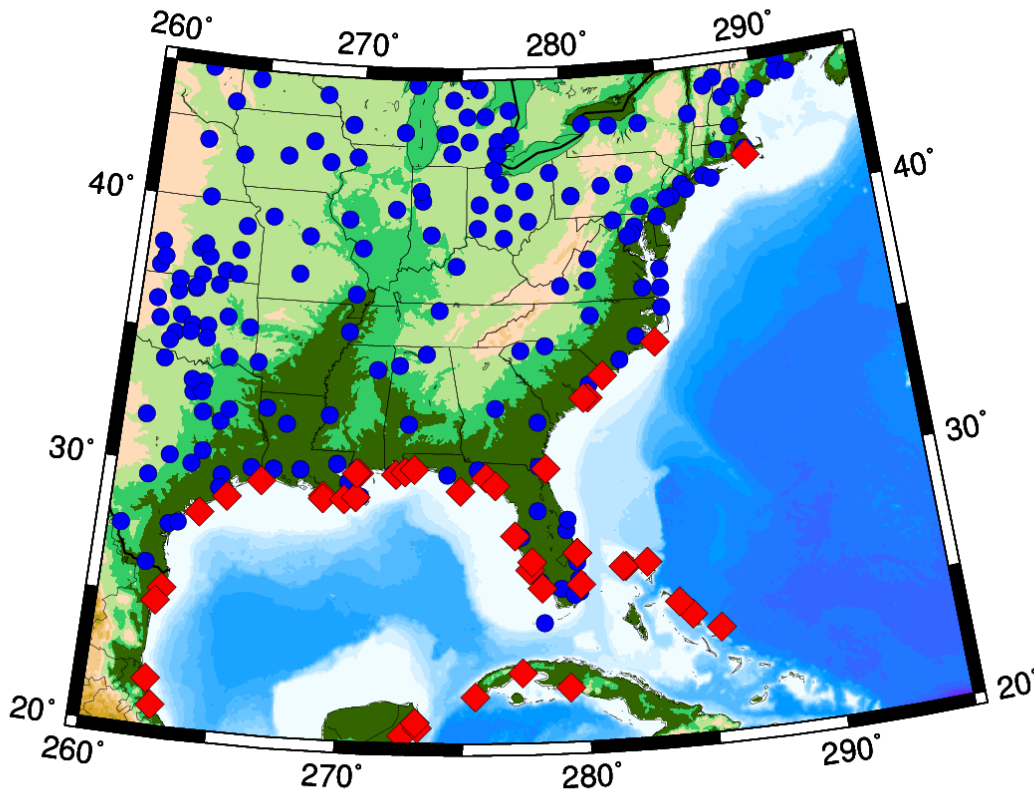

GPS stations (blue) and locations of hurricane landfalls

J.Braun, UCAR

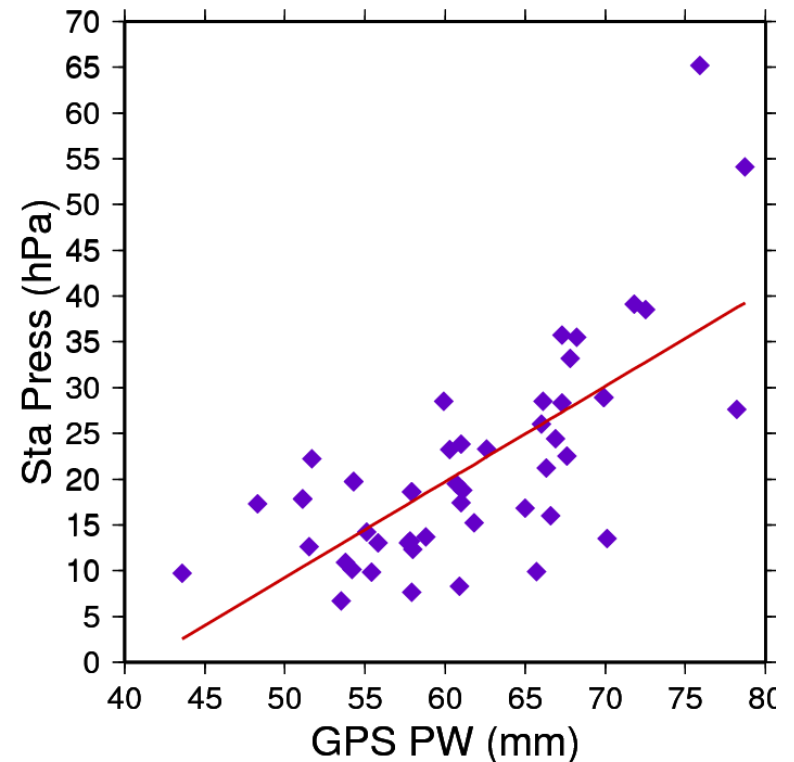

Correlation (75%) between GPS-measured precipitable water and drop in surface pressure for stations within 200 km of landfall.



# Modeling Antenna Phase-center Variations (PCVs)

- Ground antennas
  - Relative calibrations by comparison with a ‘standard’ antenna (NGS, used by the IGS prior to November 2006)
  - Absolute calibrations with mechanical arm (GEO++) or anechoic chamber
  - May depend on elevation angle only or elevation and azimuth
  - Current models are radome-dependent
  - Errors for some antennas can be several cm in height estimates
- Satellite antennas (absolute)
  - Estimated from global observations (T U Munich)
  - Differences with evolution of SV constellation mimic scale change

*Recommendation for GAMIT:* Use latest IGS absolute ANTEX file (absolute) with AZ/EL for ground antennas and ELEV (nadir angle) for SV antennas (MIT file augmented with NGS values for antennas missing from IGS)

AOA CR L1

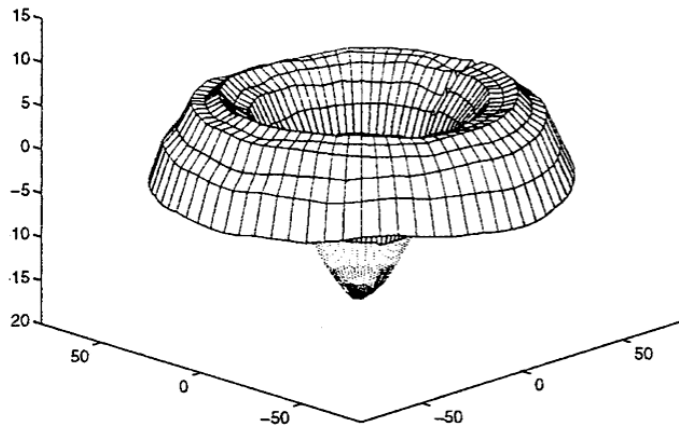

Leica L1

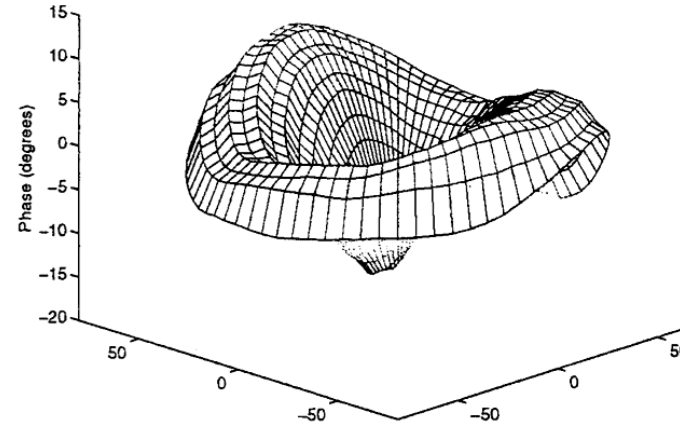

Ashtech CR L1

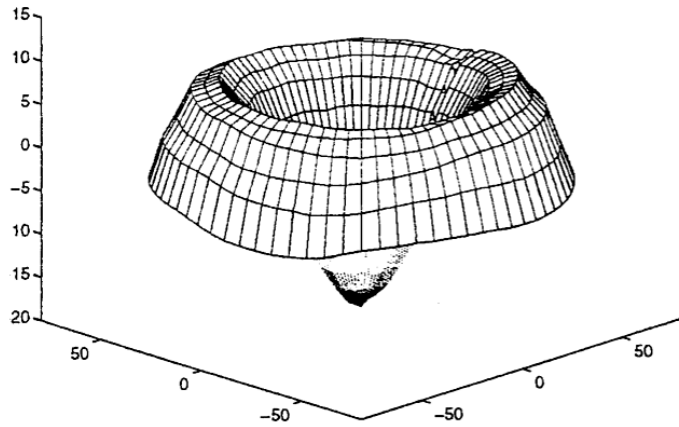

AOA Rascal L1

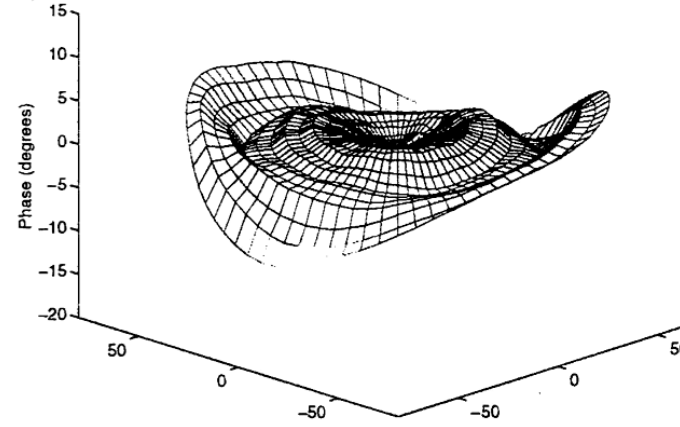

# Antenna Phase Patterns

Verticals: atmosphere and loading

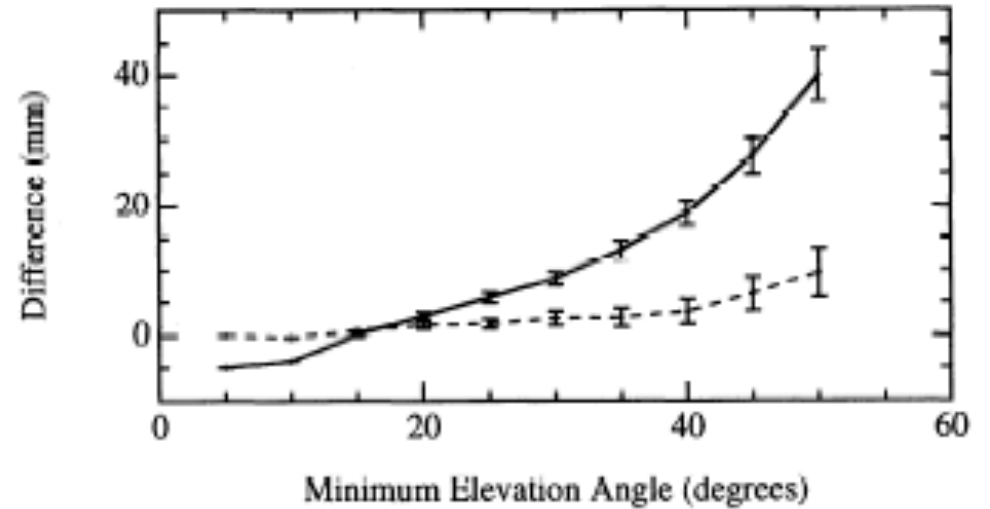
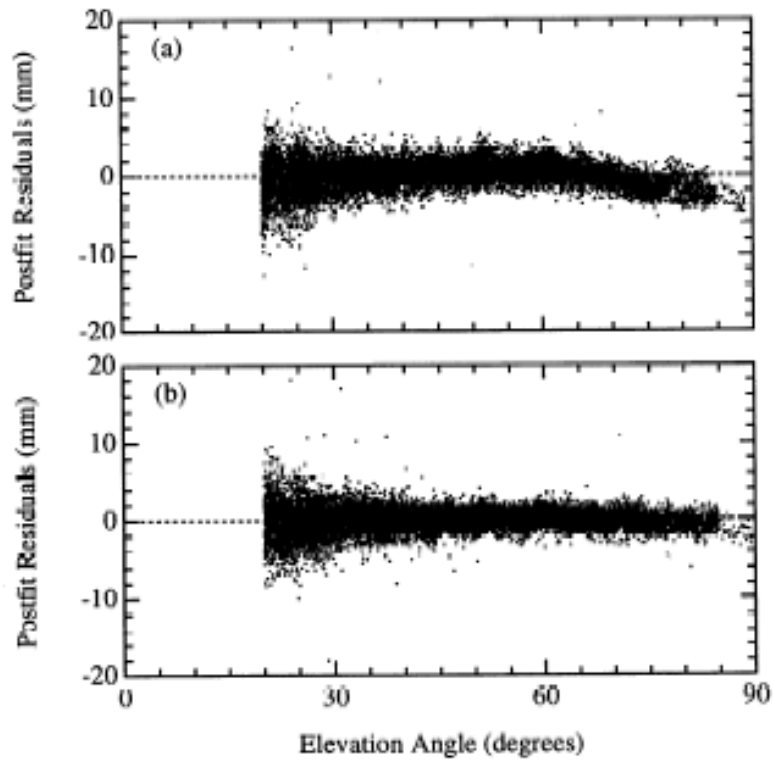

*Left:* Phase residuals versus elevation for Westford pillar, without (top) and with (bottom) microwave absorber.

*Right:* Change in height estimate as a function of minimum elevation angle of observations; solid line is with the unmodified pillar, dashed with microwave absorber added.

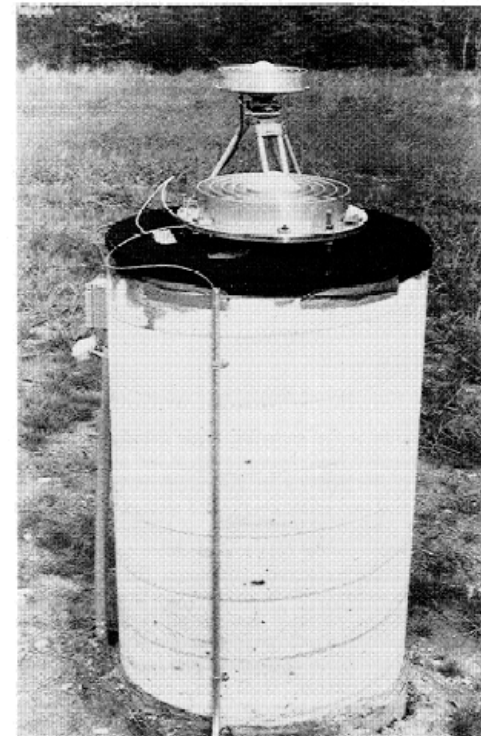

[From *Elosequi et al.*, 1995]

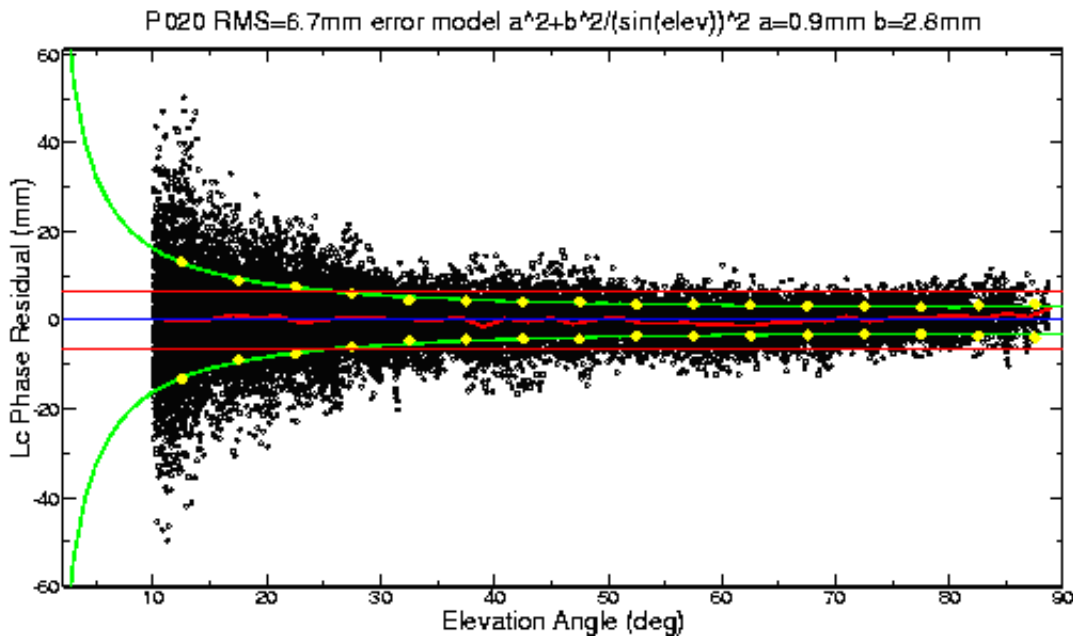

*Top:* PBO station near Lind, Washington.

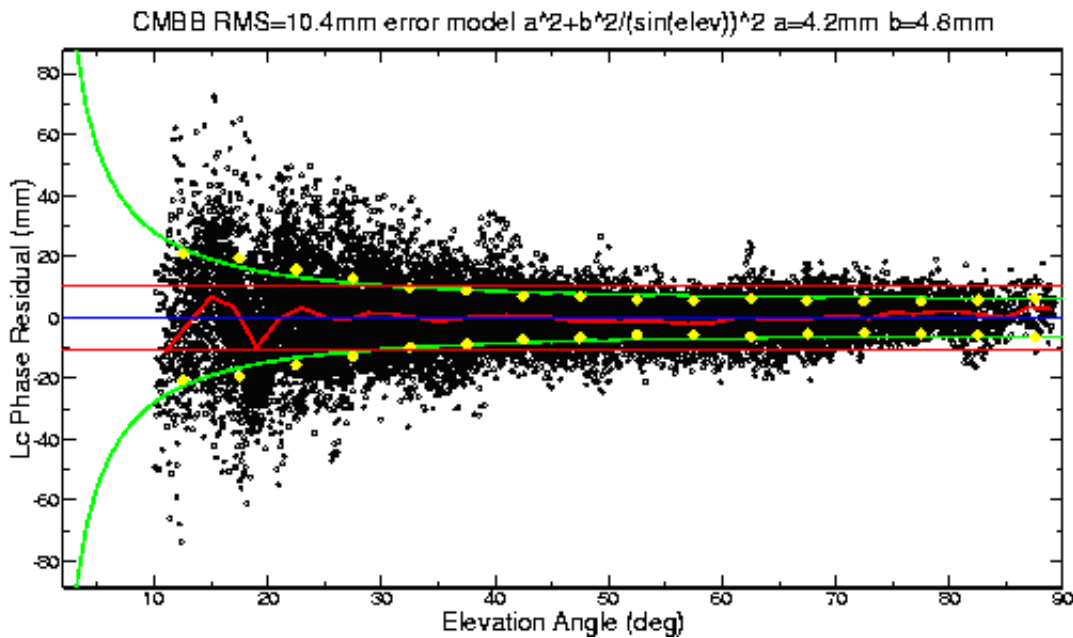

*Bottom:* BARD station CMBB at Columbia College, California

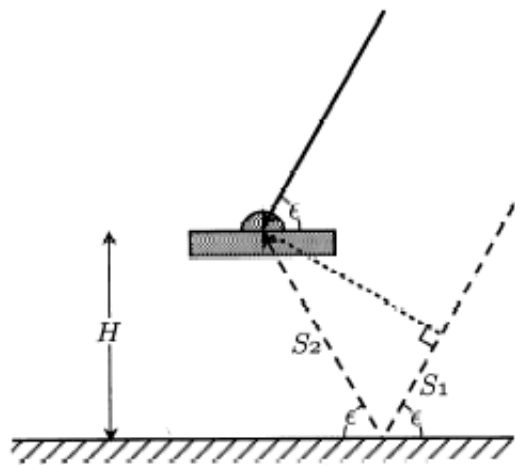

Simple geometry for incidence of a direct and reflected signal

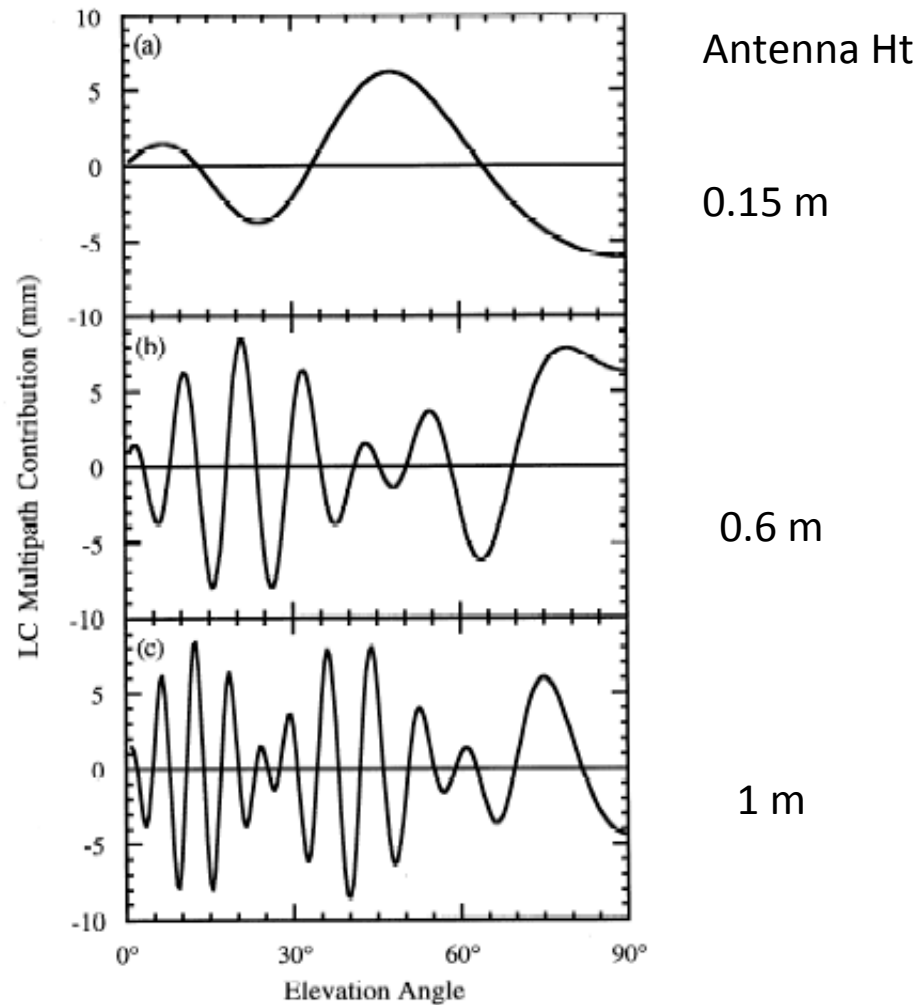

Multipath contributions to observed phase for three different antenna heights [From *Elosegui et al*, 1995]

# GPS for surface hydrology

- Possible to use direct surface multipath signal to infer local vegetation growth and decay, soil moisture and snow depth.
- <http://xenon.colorado.edu/portal/>

# References

- Larson, K. M., E. Gutmann, V. Zavorotny, J. Braun, M. Williams, and F. G. Nievinski (2009), Can We Measure Snow Depth with GPS Receivers?, *Geophys. Res. Lett.*, 36, L17502, [doi:10.1029/2009GL039430](https://doi.org/10.1029/2009GL039430).
- Larson, K. M., E. E. Small, E. Gutmann, A. Bilich, P. Axelrad, and J. Braun (2008), Using GPS multipath to measure soil moisture fluctuations: initial results, *GPS Solut.*, 12, [doi:10.1007/s10291-007-0076-6](https://doi.org/10.1007/s10291-007-0076-6).
- Larson, K. M., E. E. Small, E. Gutmann, A. Bilich, J. Braun, and V. Zavorotny (2008), Use of GPS receivers as a soil moisture network for water cycle studies, *Geophys. Res. Lett.*, 35, L24405, [doi:10.1029/2008GL036013](https://doi.org/10.1029/2008GL036013).
- Tregoning, P., and T. A. Herring (2006), Impact of a priori zenith hydrostatic delay errors on GPS estimates of station heights and zenith total delays, *J. Geophys. Res.*, 33, L23303, [doi:10.1029/2006GL027706](https://doi.org/10.1029/2006GL027706).
- Wolfe, D. E., and S. I. Gutman (2000), Developing an Operational, Surface-Based, GPS, Water Vapor Observing System for NOAA: Network Design and Results, *J. Atmos. Ocean. Technol.*, 17, 426–440, [doi:10.1175/1520-0426\(2000\)017%3C0426:DAOSBG%3E2.0.CO;2](https://doi.org/10.1175/1520-0426(2000)017%3C0426:DAOSBG%3E2.0.CO;2).