

Fundamentals of GPS for high-precision geodesy

M. A. Floyd

Massachusetts Institute of Technology, Cambridge, MA, USA

GPS Data Processing and Analysis with GAMIT/GLOBK
Earth Observatory of Singapore
17–21 July 2017

http://geoweb.mit.edu/~floyd/courses/gg/201707_EOS/

Material from R. W. King, T. A. Herring, M. A. Floyd (MIT) and S. C. McClusky (now at ANU)

Outline

- GPS Observables:
 - GPS data and the combinations of phase and pseudo-range used
- Modeling the observations: Aspects not well modeled
 - Multipath and antenna phase center models
 - Atmospheric delay propagation
- Limits of GPS accuracy
 - Monument types
 - Loading (more later)
 - Orbit quality

Instantaneous positioning with GNSS pseudoranges

Receiver solution, `teqc +qc` or `sh_rx2apr`

- Point position (`svpos`): 5–100 m
- Differential (`svdiff`): 1–10 m

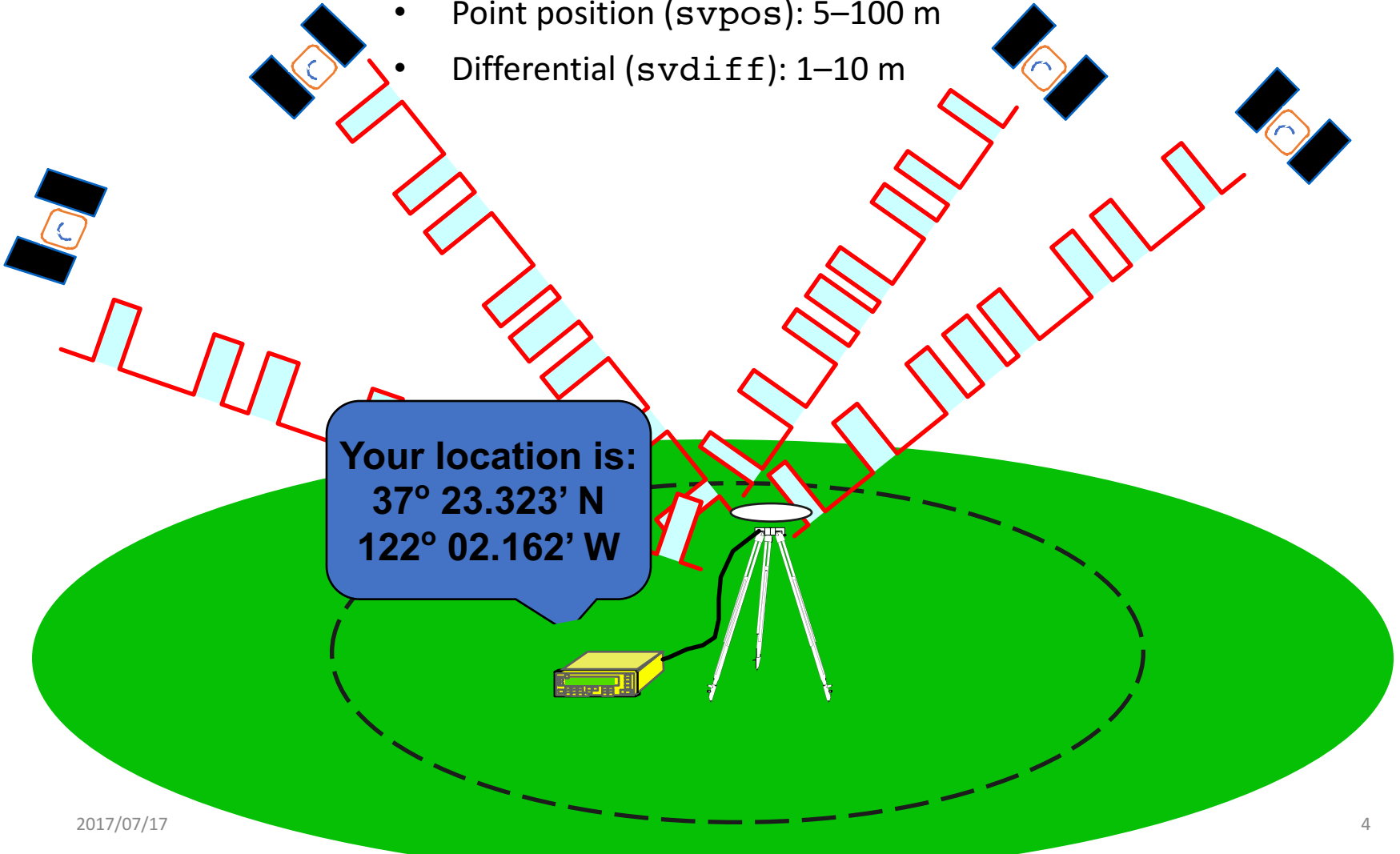
A diagram illustrating GNSS positioning. A central receiver is mounted on a tripod on a green ground plane. A yellow GNSS receiver unit is connected to the tripod. Several GNSS satellites are shown in the sky, with red lines representing signal paths from each satellite to the receiver. A blue speech bubble contains the location coordinates. A dashed black circle on the ground indicates the receiver's footprint.

Your location is:
37° 23.323' N
122° 02.162' W

Precise positioning using phase measurements

- High-precision positioning uses the phase observations
- Long-session static: tracking of change in phase over time carries most of the information
- The shorter the span the more important is ambiguity resolution

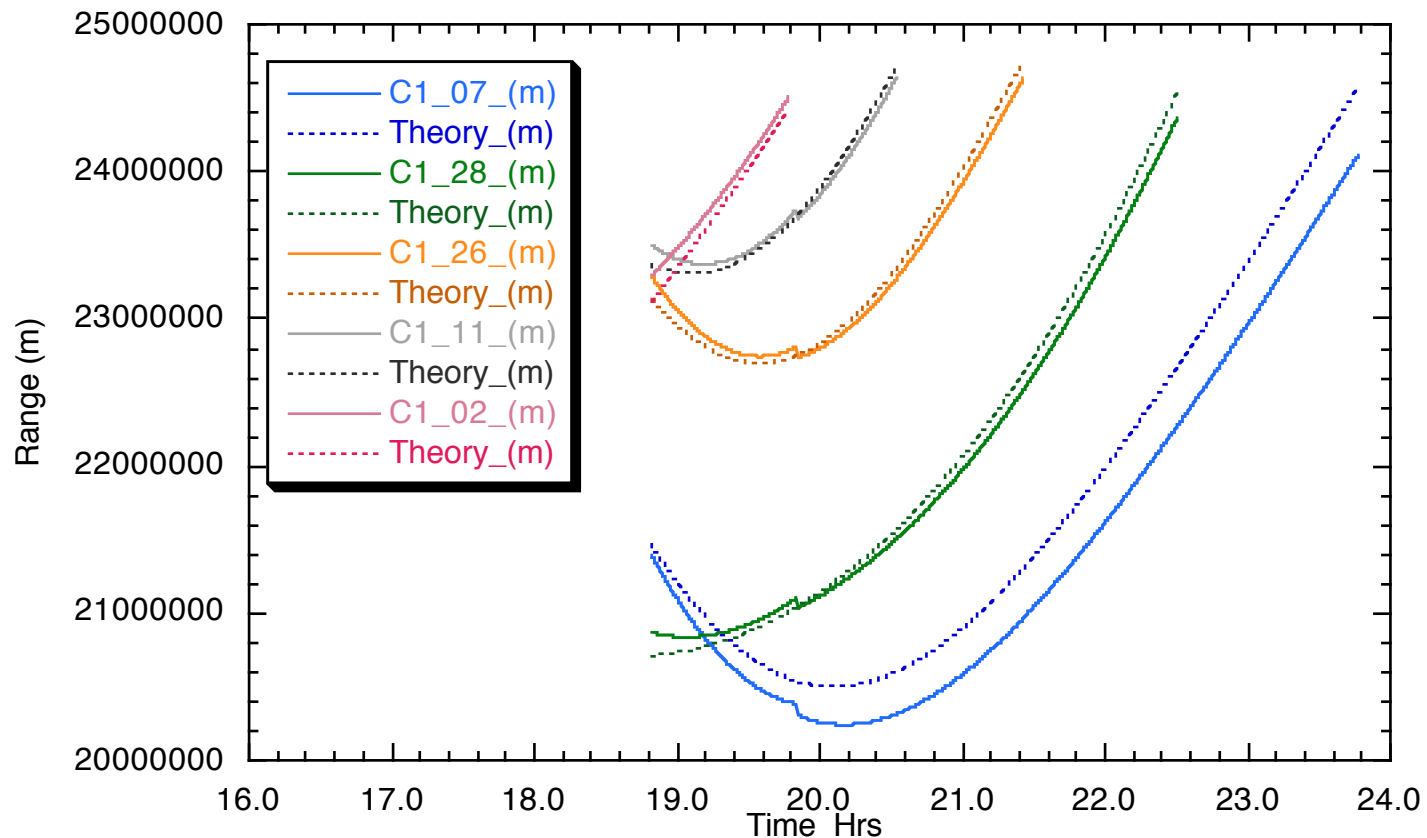

Each satellite (and station) has a different signature

Observables in data processing

Fundamental observations

L1 phase = $f_1 \times \text{range}$ ($\lambda = 19 \text{ cm}$) L2 phase = $f_2 \times \text{range}$ ($\lambda = 24 \text{ cm}$)

C1 or P1 pseudorange used separately to get receiver clock offset (time)

To estimate parameters use doubly differenced

LC = $2.55 L1 - 1.98 L2$ “ionosphere-free phase combination” (L1 cycles)

PC = $2.55 P1 - 1.55 P2$ “ionosphere-free range combination” (meters)

Double differencing (DD) cancels clock fluctuations; LC cancels almost all of ionosphere. Both DD and LC amplify noise (use L1 and L2 directly and independently for baselines $< 1 \text{ km}$)

Auxiliary combinations for data editing and ambiguity resolution:

“geometry-free combination (LG)” or “extra wide-lane” (EX-WL)

LG = $L2 - f_2/f_1 L1$ (used in GAMIT)

EX-WL = $L1 - f_1/f_2 L2$ (used in TRACK)

Removes all frequency-independent effects (geometric & atmosphere) but not multipath or ionosphere

Melbourne-Wubben wide-lane (MW-WL): phase/pseudorange combination that removes geometry and ionosphere; dominated by pseudorange noise

MW-WL = $N1 - N2 = (L1 - L2) - (\Delta f / \Sigma f)(P1 + P2) = (L1 - L2) - 0.12(P1 + P2)$

Modeling the observations

I. Conceptual/Quantitative

- Motion of the satellites
 - Earth's gravity field (flattening effect approx. 10 km; higher harmonics 100 m)
 - Attraction of Moon and Sun (100 m)
 - *Solar radiation pressure (20 m)*
 - Motion of the Earth
 - Irregular rotation of the Earth (5 m)
 - Luni-solar solid-Earth tides (30 cm)
 - *Loading due to the oceans, atmosphere, and surface water and ice (10 mm)*
 - Propagation of the signal
 - Neutral atmosphere (dry 6 m; *wet 1 m*)
 - Ionosphere (10 m but LC corrects to a few mm most of the time)
 - *Variations in the phase centers of the ground and satellite antennas (10 cm)*
- * *incompletely modeled*

Modeling the observations

II. Software structure

- Satellite orbit
 - IGS tabulated ephemeris (Earth-fixed SP3 file) [`track`]
 - GAMIT tabulated ephemeris (t-file): numerical integration by `arc` in inertial space, fit to SP3 file, may be represented by its initial conditions (ICs) and radiation-pressure parameters; requires tabulated positions of Sun and Moon
- Motion of the Earth in inertial space [`model` or `track`]
 - Analytical models for precession and nutation (tabulated); IERS observed values for pole position (wobble), and axial rotation (UT1)
 - Analytical model of solid-Earth tides; global grids of ocean and atmospheric tidal loading
- Propagation of the signal [`model` or `track`]
 - Zenith hydrostatic (dry) delay (ZHD) from pressure (met-file, VMF1, or GPT)
 - Zenith wet delay (ZWD) [crudely modeled and estimated in `solve` or `track`]
 - ZHD and ZWD mapped to line-of-sight with mapping functions (VMF1 grid or GMF)
 - Variations in the phase centers of the ground and satellite antennas (ANTEX file)

Parameter estimation

- Phase observations [`solve` or `track`]
 - Form double difference LC combination of L1 and L2 to cancel clocks & ionosphere
 - Apply a priori constraints
 - Estimate the coordinates, ZTD, and real-valued ambiguities
 - Form M-W WL and/or phase WL with ionospheric constraints to estimate and resolve the WL ($N_2 - N_1$) integer ambiguities [`autc1n` (or `solve`), `track`]
 - Estimate and resolve the narrow-lane (NL) ambiguities [`solve`, `track`]
 - Estimate the coordinates and ZTD with WL and NL ambiguities fixed
 - Estimation can be batch least squares [`solve`] or sequential (Kalman filter) [`track`]
- Quasi-observations from phase solution (h-file) [`globk`]
 - Sequential (Kalman filter)
 - Epoch-by-epoch test of compatibility (χ^2 increment) but batch output

Limits of GPS accuracy

- Signal propagation effects
 - Signal scattering (antenna phase center / multipath)
 - Atmospheric delay (mainly water vapor)
 - Ionospheric effects
 - Receiver noise
- Unmodeled motions of the station
 - Monument instability
 - Loading of the crust by atmosphere, oceans, and surface water
- Unmodeled motions of the satellites
- Reference frame

Limits of GPS Accuracy

- Signal propagation effects
 - Signal scattering (antenna phase center / multipath)
 - Atmospheric delay (mainly water vapor)
 - Ionospheric effects
 - Receiver noise
- Unmodeled motions of the station
 - Monument instability
 - Loading of the crust by atmosphere, oceans, and surface water
- Unmodeled motions of the satellites
- Reference frame

Multipath is interference between the direct and a far-field reflected signal (geometric optics apply)

To mitigate the effects:

- Avoid Reflective Surfaces
- Use a Ground Plane Antenna
- Avoid near-ground mounts
- Observe for many hours
- Remove with average from many days

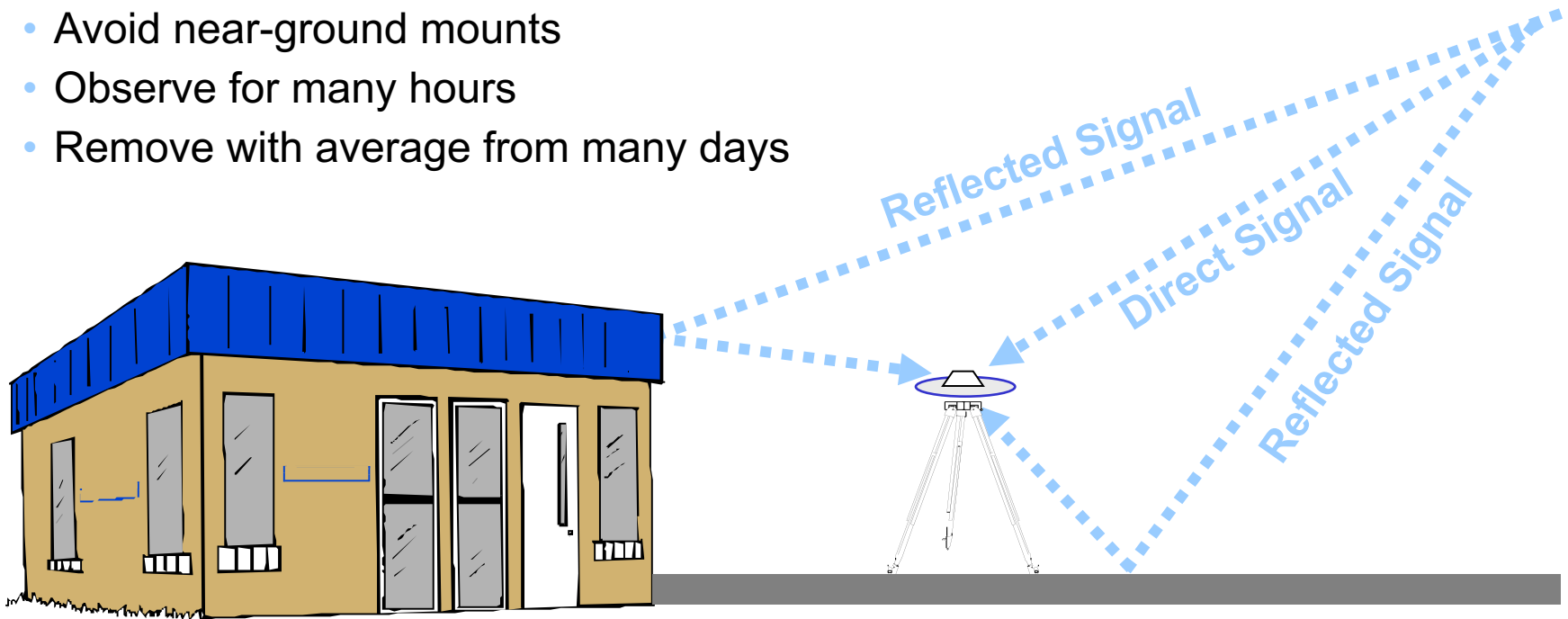

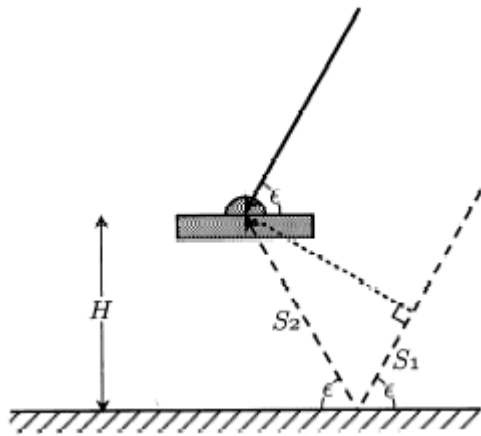

Simple geometry for incidence of a direct and reflected signal

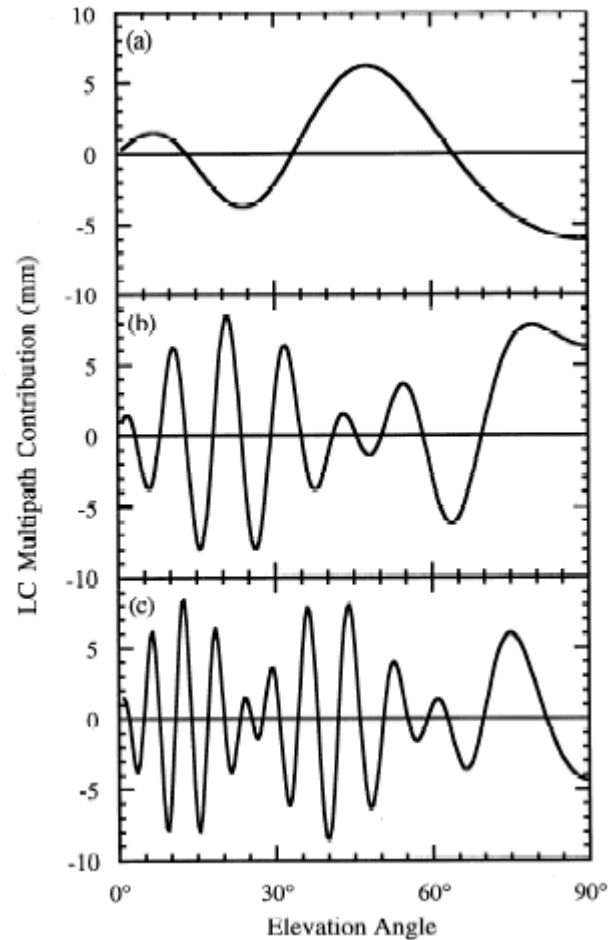

Antenna Ht

0.15 m

0.6 m

1 m

Multipath contributions to observed phase for three different antenna heights [From *Elosegui et al*, 1995]

More dangerous are near-field signal interactions that change the effective antenna phase center with the elevation and azimuth of the incoming signal

Antenna phase patterns

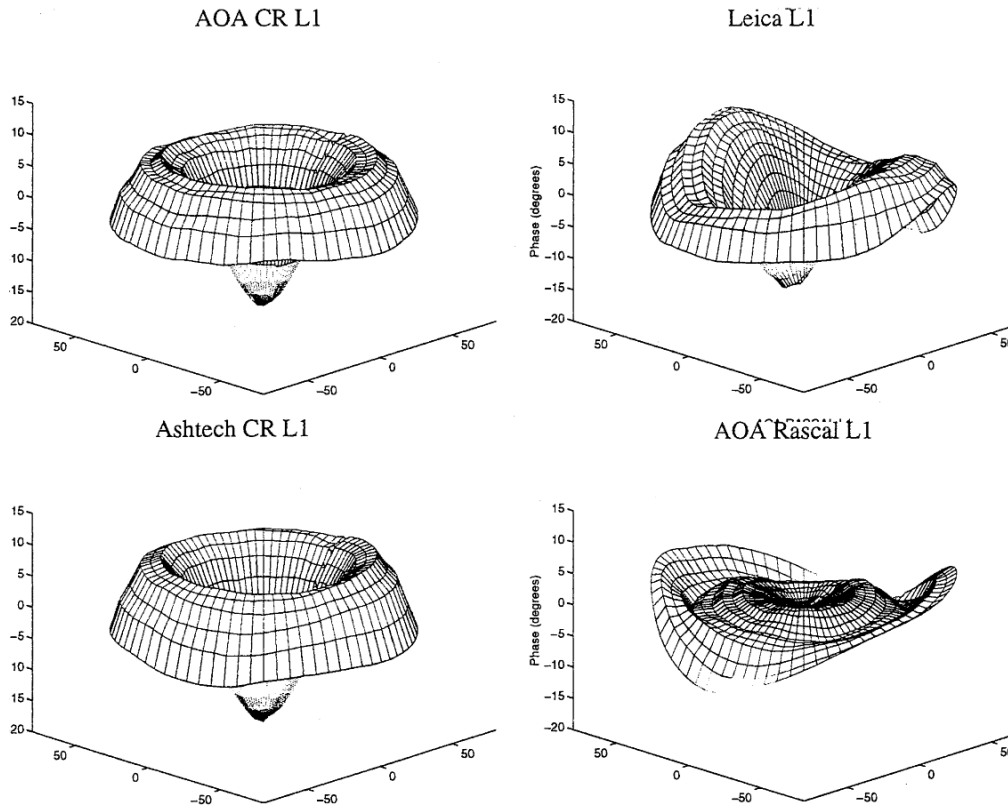

Left: Examples of the antenna phase patterns determined in an anechoic chamber...BUT the actual pattern in the field is affected by the antenna mount

To avoid height and ZTD errors of centimeters, we must use at least a nominal model for the phase-center variations (PCVs) for each antenna type

Figures courtesy of UNAVCO

Atmospheric delay

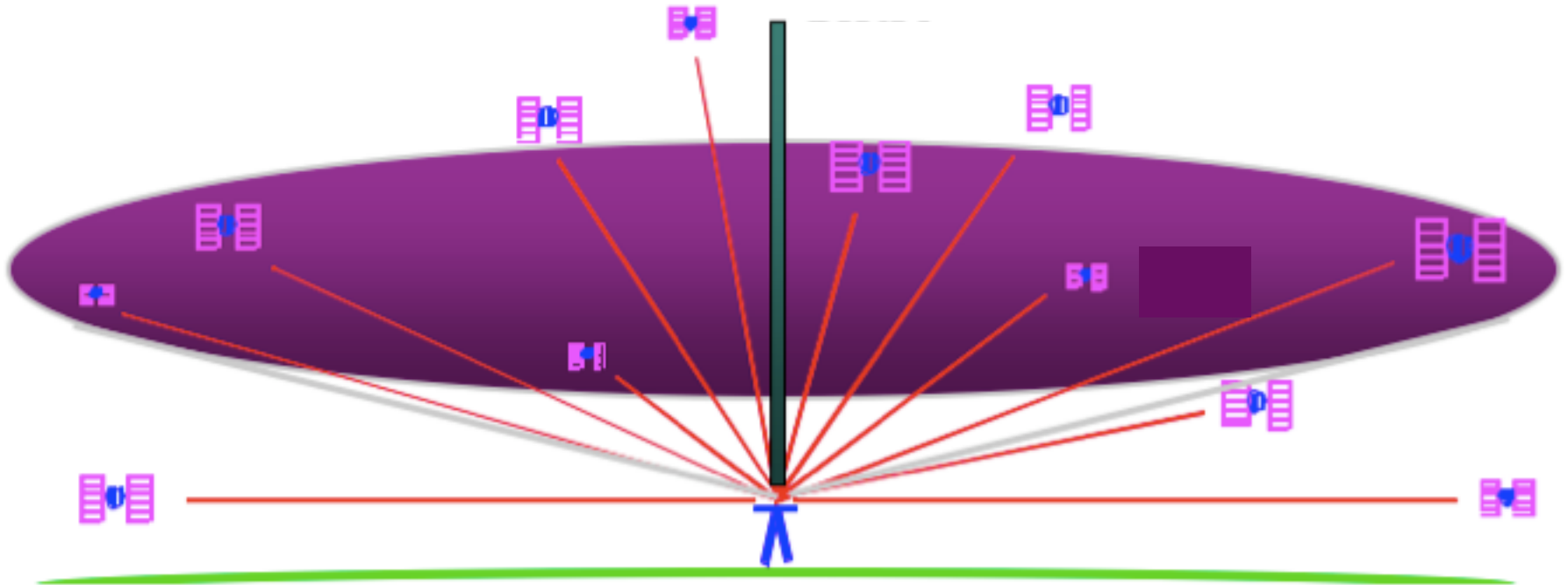

The signal from each GPS satellite is delayed by an amount dependent on the pressure and humidity and its elevation above the horizon. We invert the measurements to estimate the average delay at the zenith (green bar).

(Figure courtesy of COSMIC Program)

Zenith delay from wet and dry components of the atmosphere

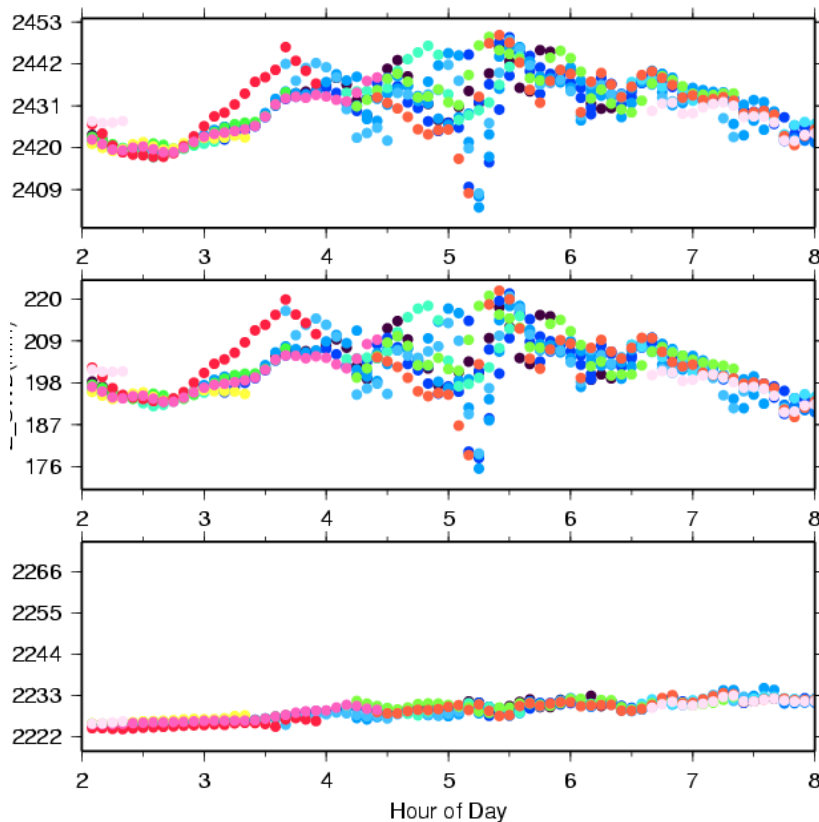

Plot courtesy of J. Braun, UCAR

- Colors are for different satellites
- Total delay is ~ 2.5 meters
 - Variability mostly caused by wet component
- Wet delay is ~ 0.2 meters
 - Obtained by subtracting the hydrostatic (dry) delay
- Hydrostatic delay is ~ 2.2 meters
 - Little variability between satellites or over time
 - Well calibrated by surface pressure

Multipath and water vapor effects in the observations

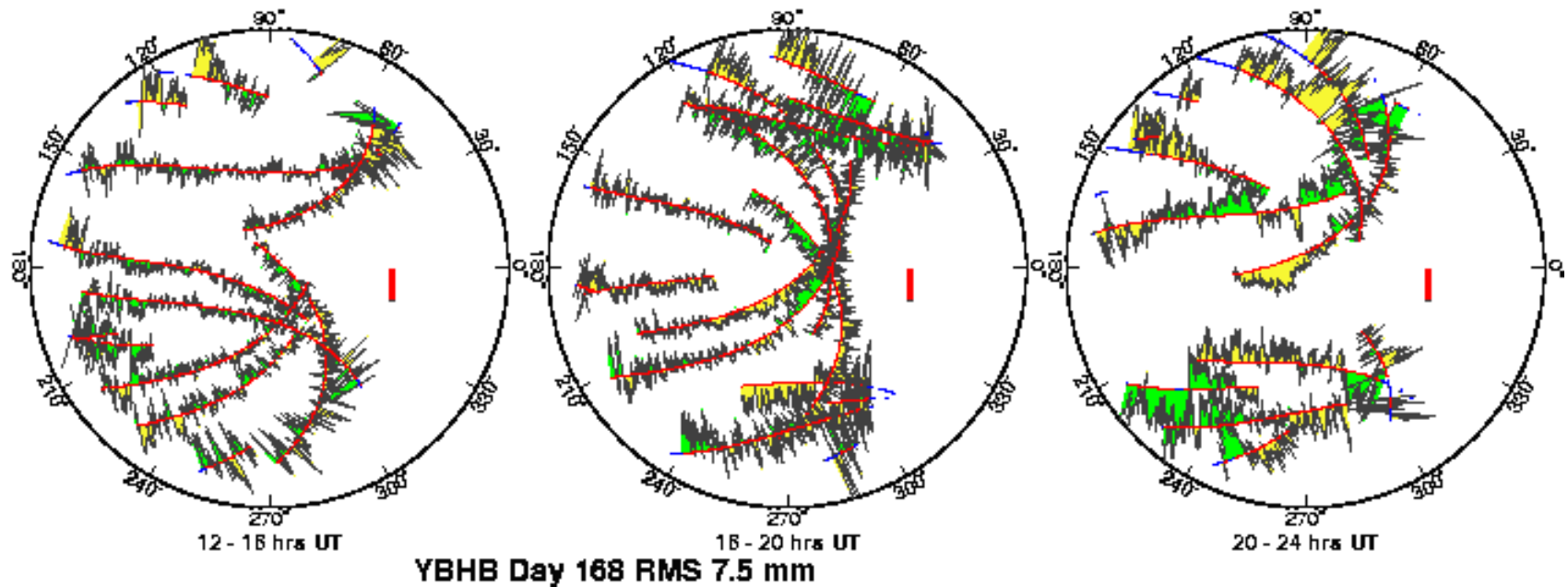

One-way (undifferenced) LC phase residuals projected onto the sky in 4-hr snapshots. Spatially repeatable noise is multipath; time-varying noise is water vapor.

Red is satellite track. Yellow and green positive and negative residuals purely for visual effect. Red bar is scale (10 mm).

Limits of GNSS accuracy

- Signal propagation effects
 - Signal scattering (antenna phase center / multipath)
 - Atmospheric delay (mainly water vapor)
 - Ionospheric effects
 - Receiver noise
- Unmodeled motions of the station
 - Monument instability
 - Loading of the crust by atmosphere, oceans, and surface water
- Unmodeled motions of the satellites
- Reference frame

Monuments Anchored to Bedrock are Critical for Tectonic Studies (not so much for atmospheric studies)

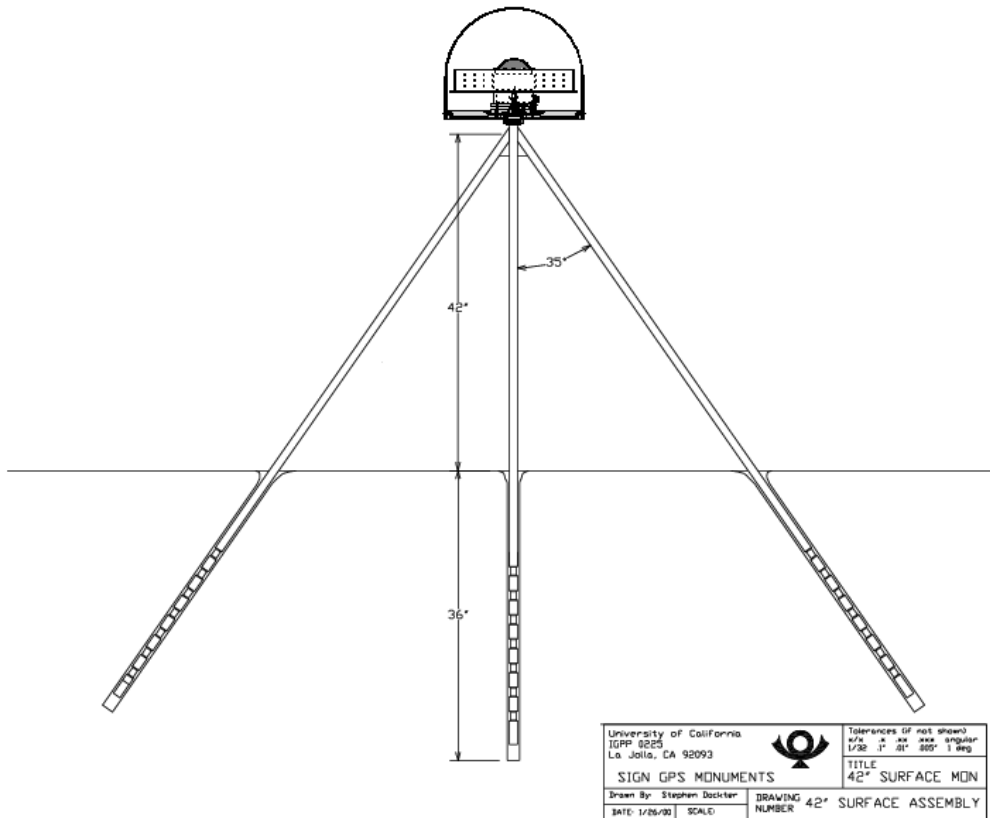

Good anchoring:

Pin in solid rock

Drill-braced (left) in fractured rock

Low building with deep foundation

Not-so-good anchoring:

Vertical rods

Buildings with shallow foundation

Towers or tall building
(thermal effects)

Annual Component of Vertical Loading

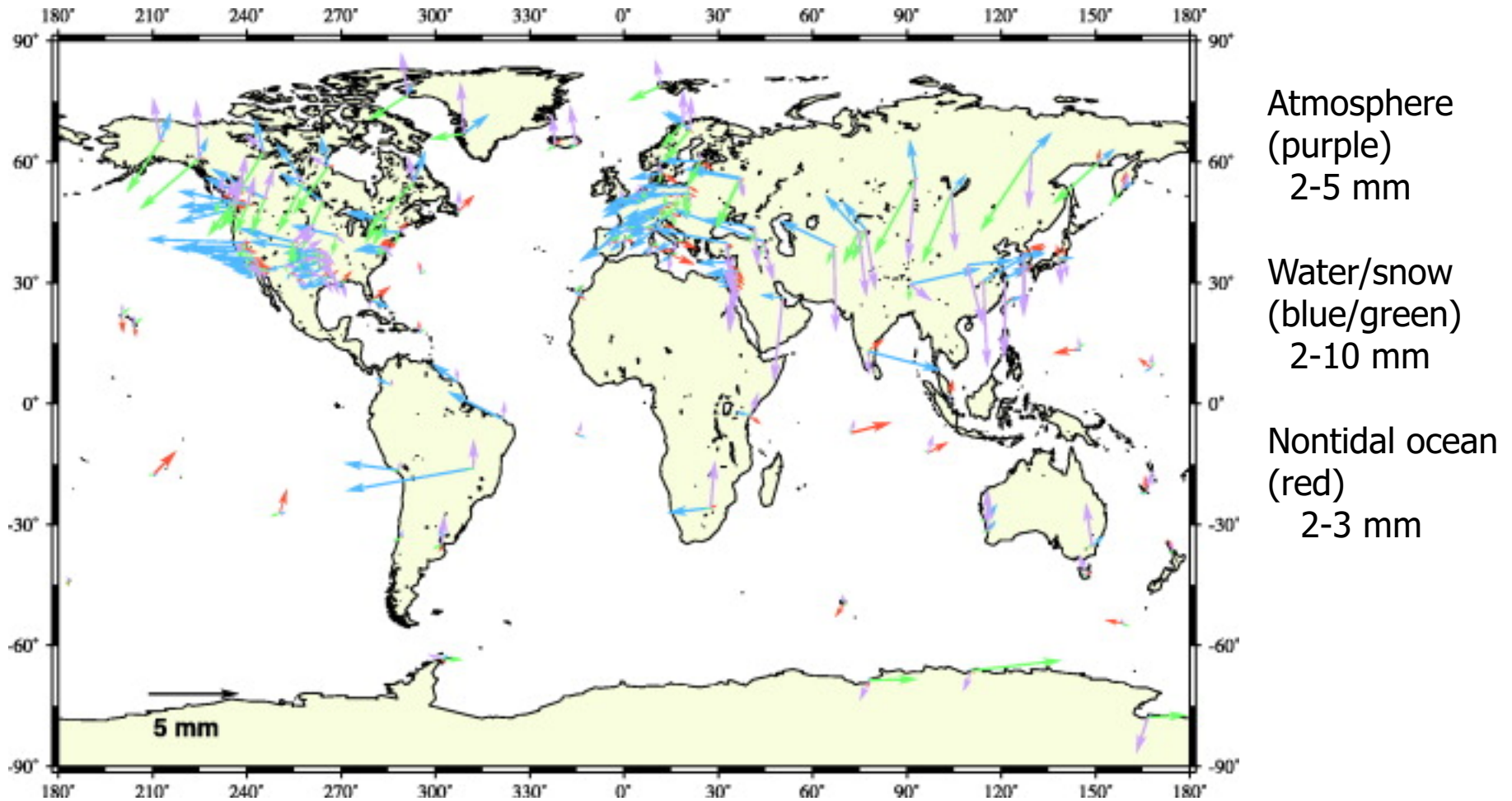

From Dong et al. *J. Geophys. Res.*, 107, 2075, 2002

Limits of GNSS accuracy

- Signal propagation effects
 - Signal scattering (antenna phase center / multipath)
 - Atmospheric delay (mainly water vapor)
 - Ionospheric effects
 - Receiver noise
- Unmodeled motions of the station
 - Monument instability
 - Loading of the crust by atmosphere, oceans, and surface water
- Unmodeled motions of the satellites
- Reference frame

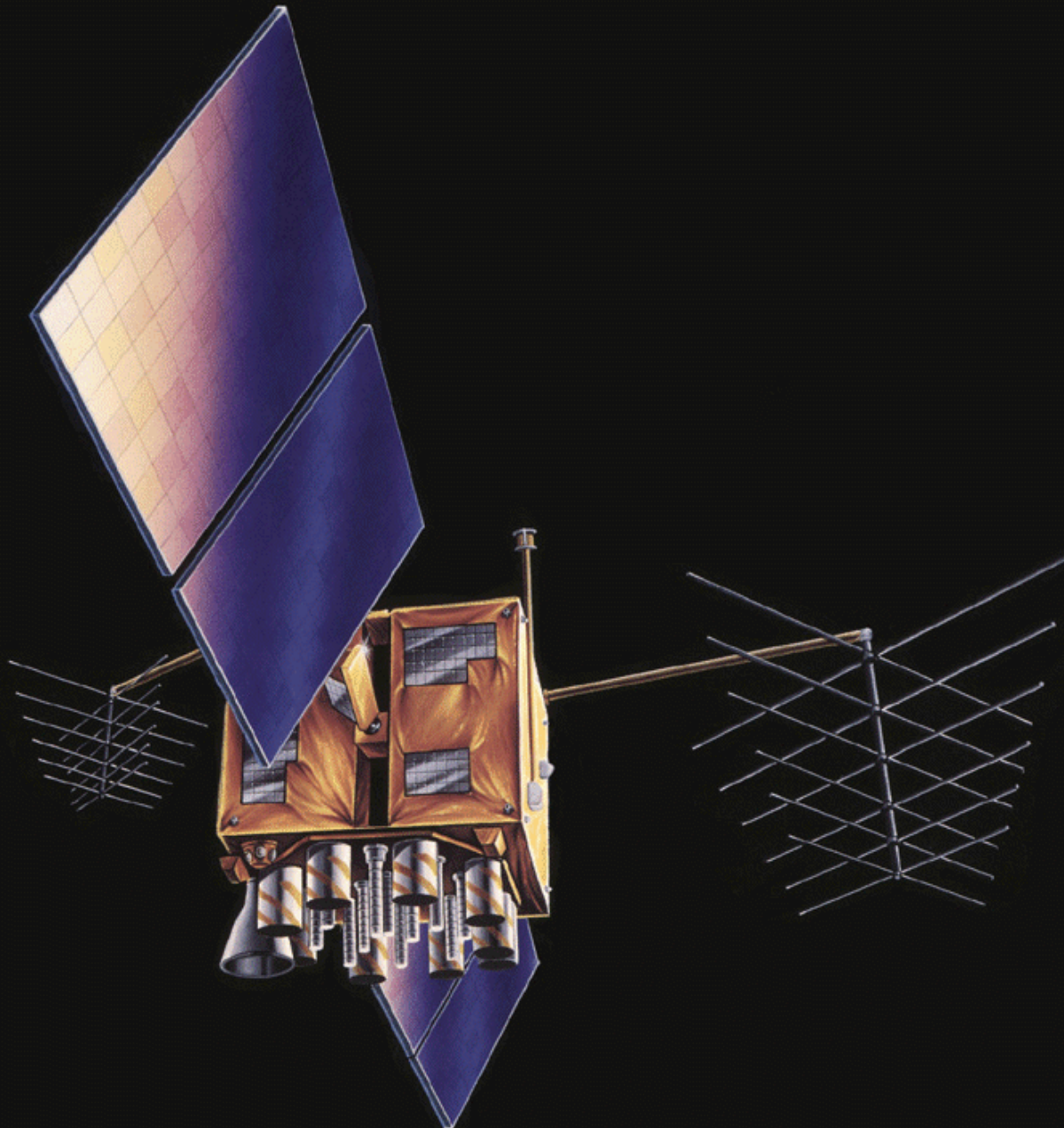

GPS Satellite

Limits to model are non-gravitational accelerations due to solar and Earth radiation, unbalanced thrusts, and outgassing; and non-spherical antenna pattern

Modeling of these effects has improved, but for global analyses remain a problem

Final Orbits (AC solutions compared to IGS Final)

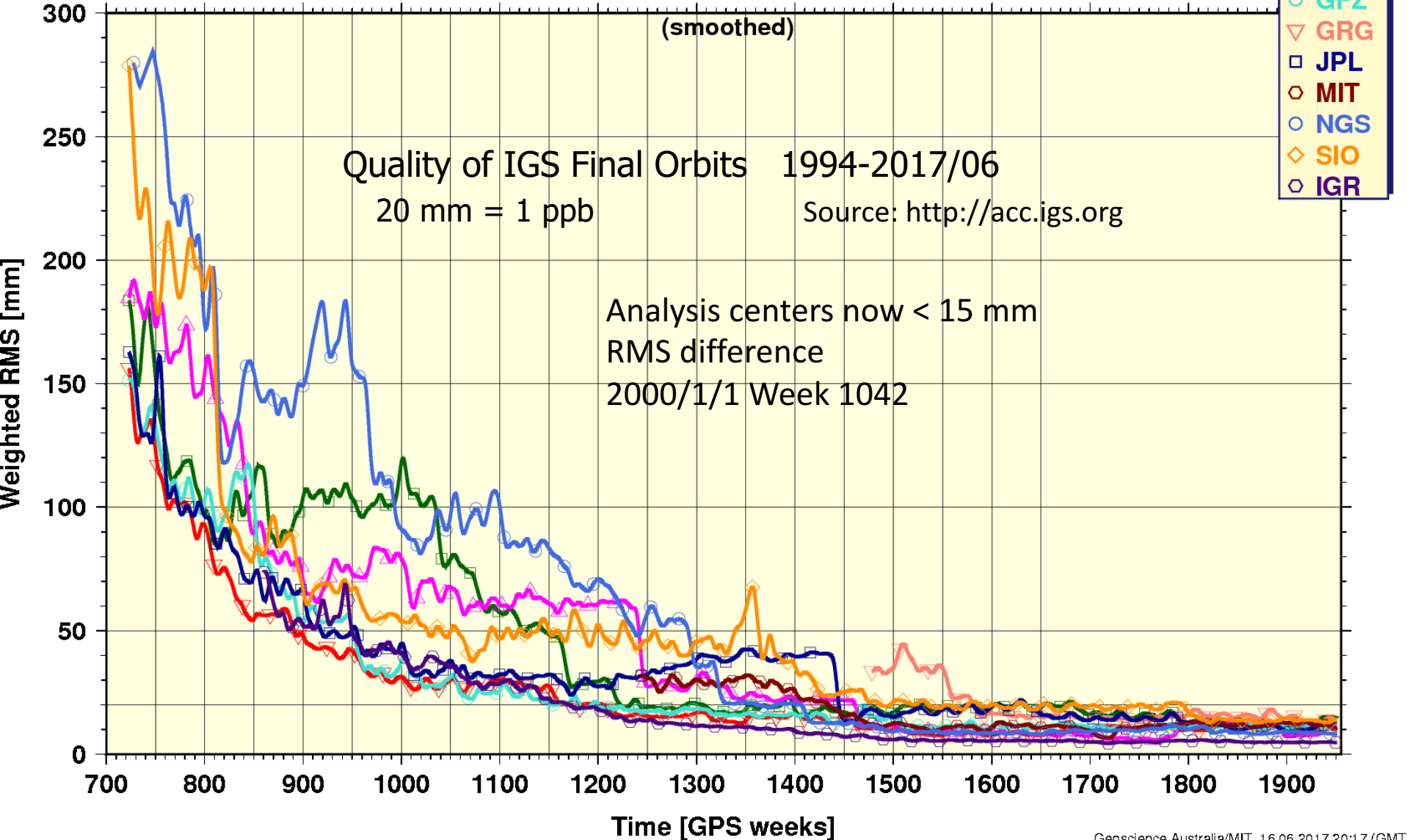

Geoscience Australia/MIT, 16.06.2017 20:17 (GMT)

Limits of GNSS accuracy

- Signal propagation effects
 - Signal scattering (antenna phase center / multipath)
 - Atmospheric delay (mainly water vapor)
 - Ionospheric effects
 - Receiver noise
- Unmodeled motions of the station
 - Monument instability
 - Loading of the crust by atmosphere, oceans, and surface water
- Unmodeled motions of the satellites
- **Reference frame**

Reference frames

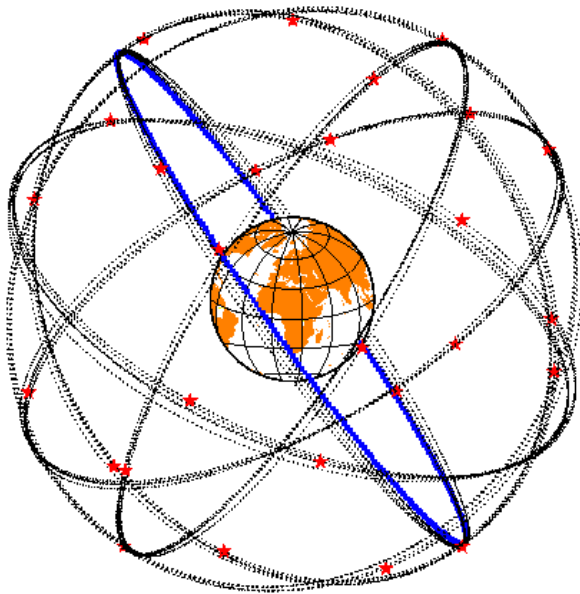

- Basic Issue: How well can you relate your position estimates over time to:
 1. A set of stations whose motion is well modeled?
 2. A block of crust that allows you to interpret the motions?
- Implementation: How to use the available data and the features of GLOBK to realize the frame(s)
- Both questions to be addressed in detail in later lectures

Effect of Orbital and Geocentric Position Error/Uncertainty

High-precision GPS is essentially relative !

Baseline error/uncertainty $\sim \frac{\text{Baseline distance}}{\text{SV altitude}}$ x geocentric SV or position error

SV errors reduced by averaging:

Baseline errors are $\sim 0.2 \cdot \text{orbital error} / 20,000 \text{ km}$

e.g. 20 mm orbital error = 1 ppb or 1 mm on 1000 km baseline

Network (“absolute”) position errors less important for small networks

e.g. 5 mm position error ~ 1 ppb or 1 mm on 1000 km baseline

10 cm position error ~ 20 ppb or 1 mm on 50 km baseline

* But SV and position errors are magnified for short sessions

Summary

- GPS Observables:
 - GPS data and the combinations of phase and pseudo-range used
- Modeling the observations: Aspects not well modeled
 - Multipath and antenna phase center models
 - Atmospheric delay propagation
- Limits of GPS accuracy
 - Monument types
 - Loading (more later)
 - Orbit quality: Since 2000 less than 40 mm corresponding to 2 ppb. Hard to improve on the IGS orbits.